



Pompe centrifughe monogirante estremamente silenziosa adatta ad applicazioni domestiche civili e industriali. La curva estremamente piatta garantisce pressioni pressoché costanti al variare della portata.

Single impeller centrifugal pumps, extremely silent suitable for household, civil and industrial applications, with a very flat curve to guarantee constant pressure at the variation of the flow.

Bombas centrífugas con un rodete extremadamente silenciosas apropiadas en aplicaciones domésticas civiles e industriales con una curva extremadamente plana; garantizan presiones casi constantes cuando varía el caudal.

Pompes centrifuges monoroue très silencieuses, aptes aux applications domestiques, civiles et industrielles. La courbe caractéristique très plate garantit des pressions quasiment constantes en cas de variation du débit.

#### Pump model code

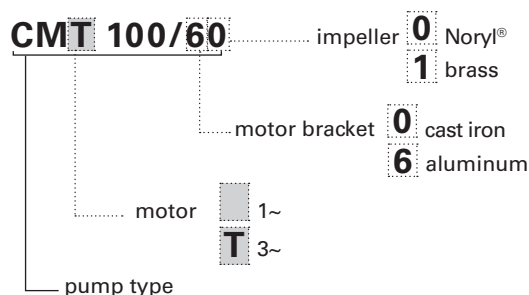

#### CARATTERISTICHE COSTRUTTIVE / CONSTRUCTION FEATURES CARACTERÍSTICAS CONSTRUCTIVAS / CARACTÉRISTIQUES D'EXÉCUTION

<b>Corpo pompa</b> <b>Pump body</b> <b>Cuerpo bomba</b> <b>Corps de pompe</b>	ghisa cast iron fundición fonte
<b>Supporto motore</b> <b>Motor bracket</b> <b>Soporte motor</b> <b>Support moteur</b>	ghisa; alluminio (CM75÷100) cast iron; aluminium (CM75÷100) fundición; aluminio (CM75÷100) fonte; aluminium (CM75÷100)
<b>Girante</b>	Noryl® (CM45) Noryl® o ottone (CM50-314) Ottone (CM400-550)
<b>Impeller</b>	Noryl® (CM45) Noryl® or brass (CM50-314) Brass (CM400-550)
<b>Rodete</b>	Noryl® (CM45) Noryl® o latón (CM50-314) Latón (CM400-550)
<b>Turbine</b>	Noryl® (CM45) Noryl® ou laitón (CM50-314) Laitón (CM400-550)
<b>Tenuta meccanica</b> <b>Mechanical seal</b> <b>Sello mecánico</b> <b>Garniture mécanique</b>	ceramica-grafite ceramic-graphite cerámica-grafito céramique-graphite
<b>Albero motore</b>	acciaio AISI 416 (CM45÷100) acciaio AISI 303 (CM164÷550)
<b>Motor shaft</b>	stainless steel AISI 416 (CM45÷100) stainless steel AISI 303 (CM164÷550)
<b>Eje motor</b>	acero AISI 416 (CM45÷100) acero AISI 303 (CM164÷550)
<b>Arbre moteur</b>	acier AISI 416 (CM45÷100) acier AISI 303 (CM164÷550)
<b>Temperatura del liquido</b>	girante Noryl®: 0 - 50 °C girante ottone: 0 - 90 °C
<b>Liquid temperature</b>	Noryl® impeller: 0 - 50 °C brass impeller: 0 - 90 °C
<b>Temperatura del liquido</b>	rodete Noryl®: 0 - 50 °C rodete latón: 0 - 90 °C
<b>Température du liquide</b>	turbine Noryl®: 0 - 50 °C turbine laitón: 0 - 90 °C
<b>Pressione di esercizio</b> <b>Operating pressure</b> <b>Presión de trabajo</b> <b>Pression de fonctionnement</b>	max 6 bar (CM45-100) max 8 bar (CM164-550)

#### MOTORE / MOTOR / MOTOR / MOTEUR

<b>Motore 2 poli a induzione</b>	3~ 230/400V-50Hz
<b>2 pole induction motor</b>	1~ 230V-50Hz (with thermal protection up to MEC 80)
<b>Motor de 2 polos a inducción</b>	
<b>Moteur à induction à 2 pôles</b>	
<b>Classe di isolamento</b> <b>Insulation class</b> <b>Clase de aislamiento</b> <b>Classe d'isolation</b>	F
<b>Grado di protezione</b> <b>Protection degree</b> <b>Grado de protección</b> <b>Protection</b>	IP44

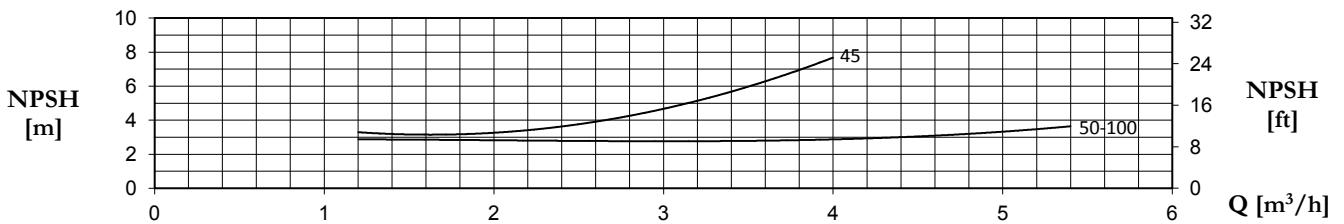
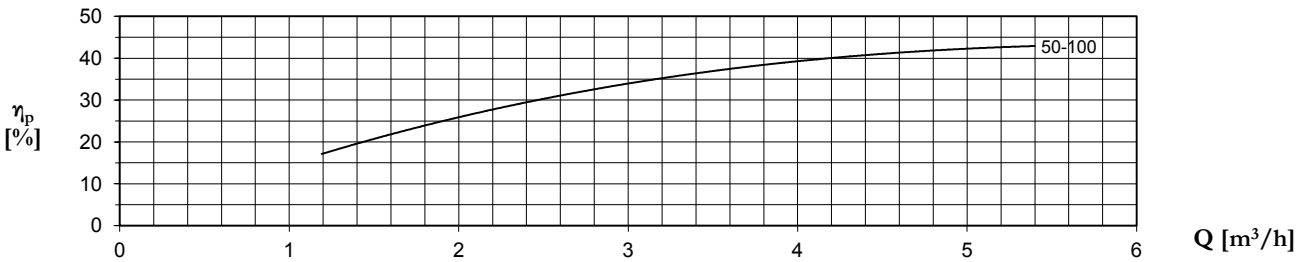
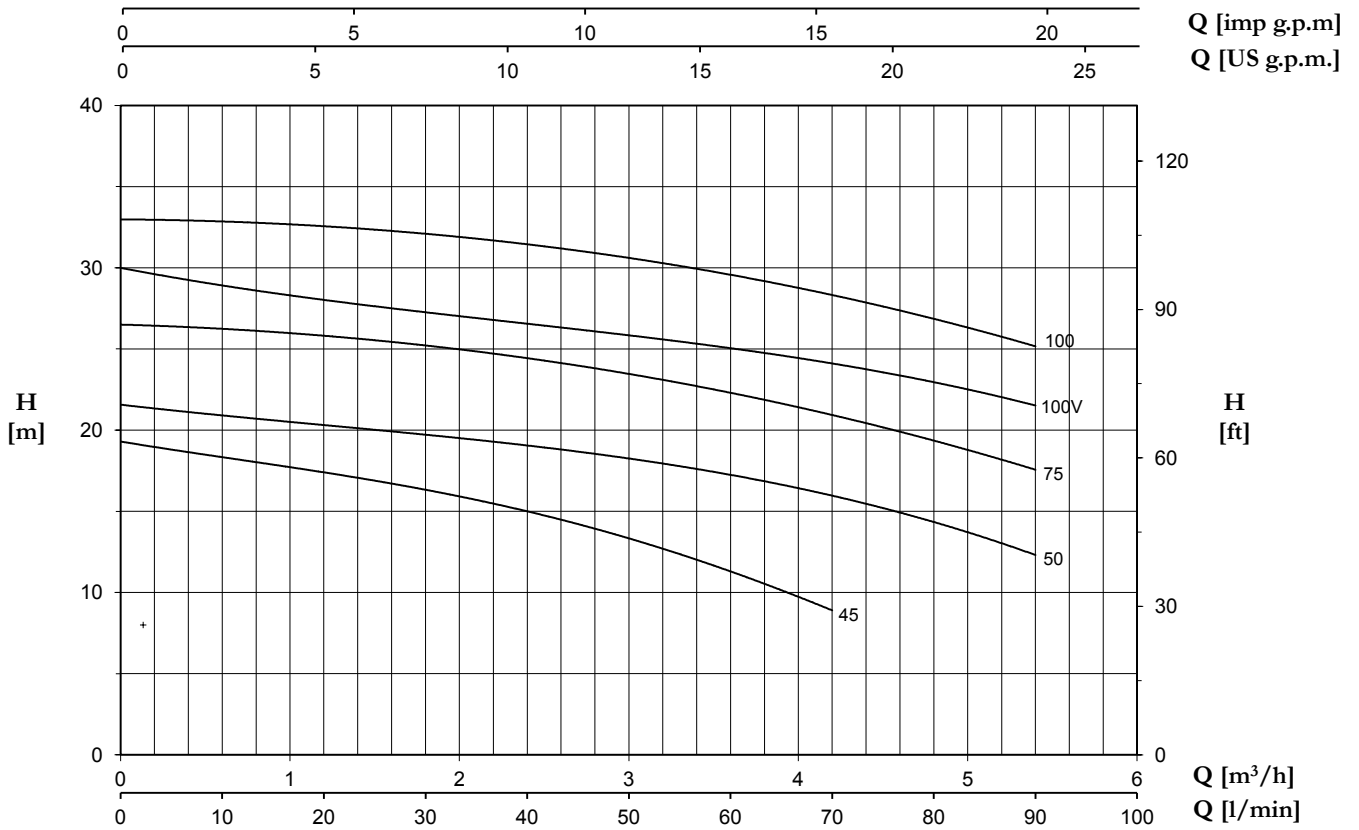

TYPE		P2		P1 (kW)		AMPERE		Q (m³/h - l/min)						
1~	3~					1~	3~	0	1,2	2,4	3,6	4,2	4,8	5,4
						1x230 V 50 Hz	3x400 V 50 Hz	0	20	40	60	70	80	90
		(HP)	(kW)	1~	3~	H (m)								
CM 45	CMT 45	0,4	0,3	0,51	0,56	2,3	1	19,3	17,4	15	11,3	8,9	-	-
CM 50	CMT 50	0,5	0,37	0,59	0,65	2,8	1,1	21,5	20,5	19	17	15,8	15	12
CM 75	CMT 75	0,8	0,59	0,9	0,94	4,5	1,7	26,5	25,8	24,5	22,2	20,9	19,5	17,5
CM 100V	-	1	0,74	1,05	-	4,6	-	30	28	26,6	25	24,1	23	21,5
CM 100	CMT 100	1	0,74	1,16	1,17	5,7	2	33	32,5	31,5	29,6	28,3	26,8	25,2



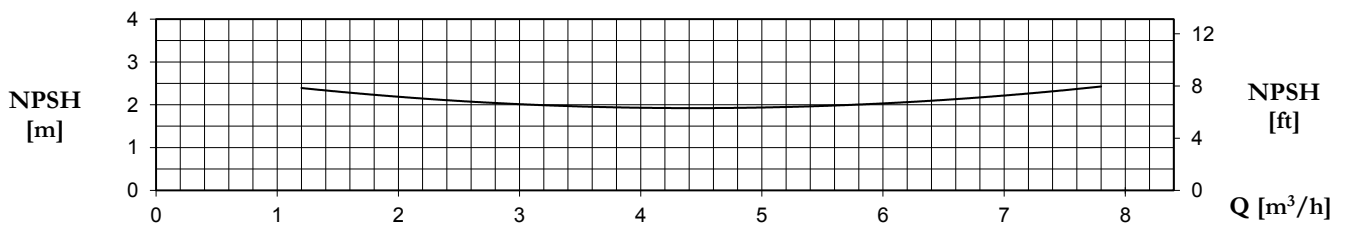
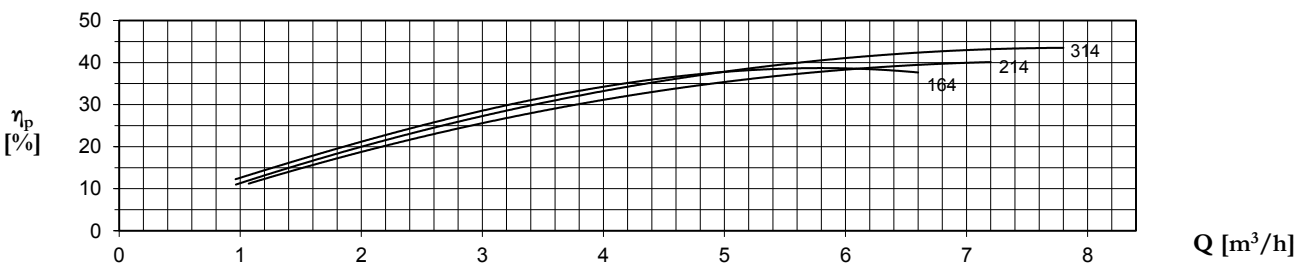
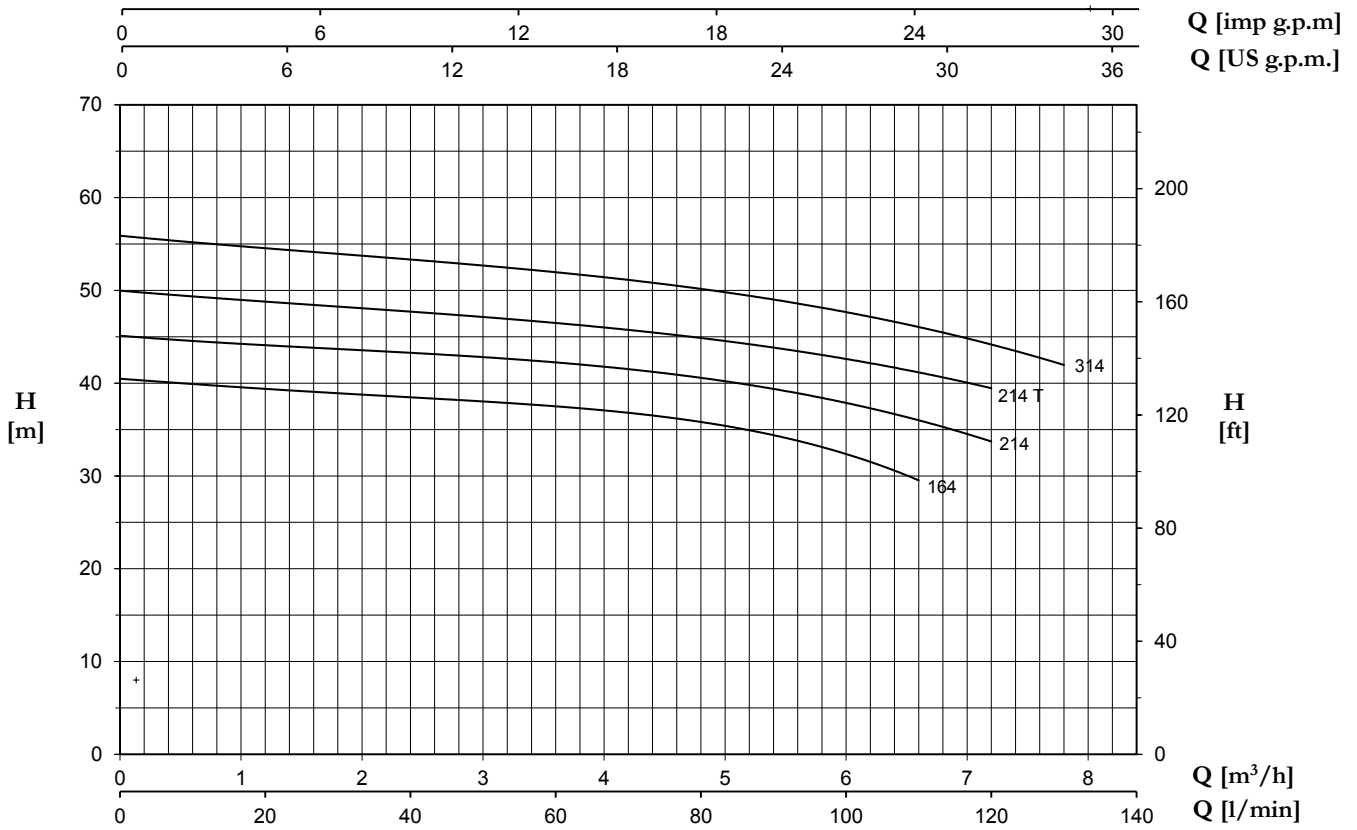

TYPE		P2		P1 (kW)		AMPERE		Q (m <sup>3</sup> /h - l/min)								
1~	3~	(HP)	(kW)	1~	3~	1~	3~	0	1,2	2,4	3,6	4,8	5,4	6,6	7,2	7,8
						1x230 V 50 Hz	3x400 V 50 Hz	0	20	40	60	80	90	110	120	130
								H (m)								
CM 164	CMT 164	1,5	1,1	1,9	1,8	8,5	3,4	40,5	39,3	38,6	37,5	35,6	34,6	29,5	-	-
CM 214	-	2	1,5	2,2	-	10,3	-	45,1	44,1	43,3	42,3	40,5	39,2	36,4	33,5	-
-	CMT 214	2	1,5	-	2,43	-	4,9	50	48,7	47,8	46,5	44,9	43,7	41,3	39,4	-
CM 314	CMT 314	3	2,2	2,85	2,67	13,5	5,1	55,9	54,5	53,4	52	50,1	48,9	46,2	44,2	41,9



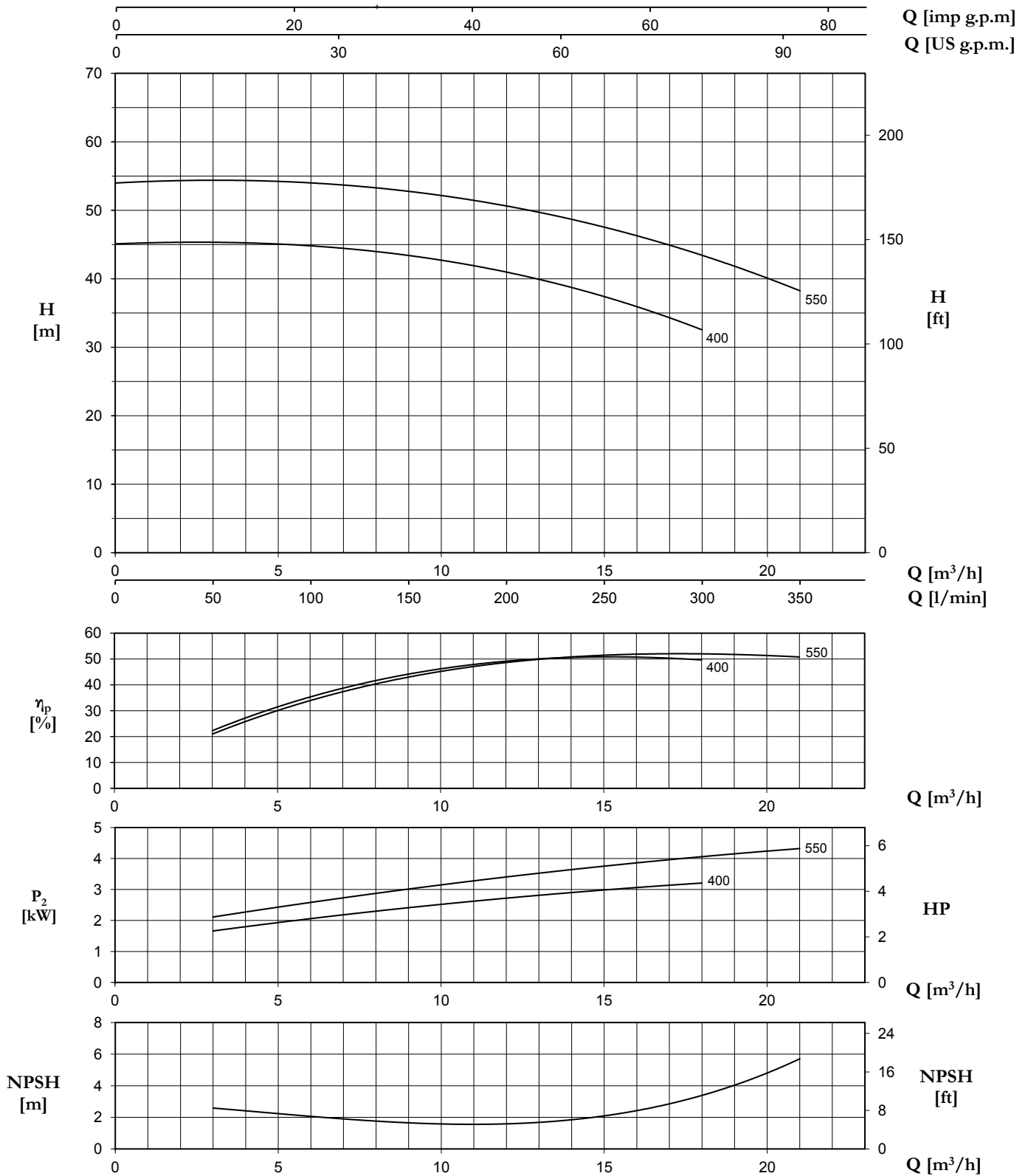



TYPE		P2		P1 (kW)		AMPERE		Q (m³/h - l/min)							
1~	3~	(HP)	(kW)	1~	3~	1~	3~	0	3	6	9	12	15	18	21
								0	50	100	150	200	250	300	350
						1x230 V 50 Hz	3x400 V 50 Hz	H (m)							
CM 400	CMT 400	4	3	3,6	3,7	16,0	6,7	45,1	45,2	44,9	43,4	40,9	37,4	32,5	-
-	CMT 550	5,5	4	-	4,9	-	9,0	54,1	54,1	54,0	52,9	50,7	47,5	43,2	38,4

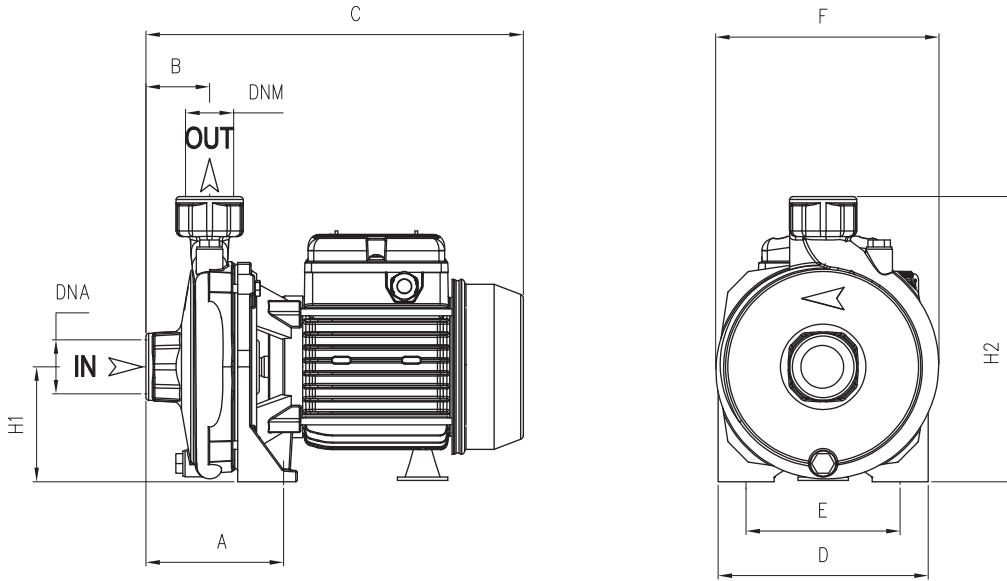



TYPE	DIMENSIONS (mm)														
	A	B	C	D	E	F	H1	H2	DNA	DNM	I	L	M		
<b>CM 45</b>	95	45.5	265	150	110	160	82	202	1" G	1" G	290	175	225	8,5	
<b>CM 50</b>	95	45.5	265	150	110	160	82	202	1" G	1" G	290	170	230	9,5	
<b>CM 75</b>	110	46.5	300	180	140	185	97	234	1" G	1" G	325	200	265	13,5	T 13
<b>CM 100 V</b>	110	46,5	300	180	140	185	97	234	1" G	1" G	325	200	265	14	T 13,5
<b>CM 100</b>	110	46.5	300	180	140	185	97	234	1" G	1" G	325	200	265	15	T 14,5
<b>CM 164</b>	117	46.5	348	220	180	225	115	285	1" 1/4 G	1" G	370	240	315	23	T 22
<b>CM 214</b>	117	46.5	348	220	180	225	115	285	1" 1/4 G	1" G	370	240	315	24	T 23
<b>CM 314</b>	117	46.5	410 T 348	220	180	225	115	285	1" 1/4 G	1" G	370	240	315	29	T 23,5
<b>CM 400</b>	108	54	460	240	190	250	133	323	2" G	1" 1/4 G	480	255	342	46	T 41,5
<b>CMT 550</b>	108	54	460	240	190	250	133	323	2" G	1" 1/4 G	480	255	342	46	T 45,5

TYPE				
	TRUCK		CONTAINER	
	PALLET (cm)	N° pumps	PALLET (cm)	N° pumps
<b>CM 45-50</b>	80x120x145	102	80x120x190	136
<b>CM 75-100</b>	85x110x145	65	85x110x195	91
<b>CM 164-CMT314</b>	85x110x140	40	85x110x170	60
<b>CM 314</b>	85x110x150	24	85x110x180	30
<b>CM 400-550</b>	85x110x150	24	85x110x180	30

