

SIEMENS



# SITRANS F

Electromagnetic flowmeters

SITRANS F M MAG 5000/6000

Operating Instructions

Edition

12/2013

Answers for industry.





## SITRANS F

### Flowmeters SITRANS F M MAG 5000/6000

#### Operating Instructions



Electromagnetic flow transmitter designed for use with  
flow sensor types  
MAG 1100/1100 F/3100/3100 P/5100 W  
Compact and remote installation

<u>Introduction</u>	<b>1</b>
<u>Safety notes</u>	<b>2</b>
<u>Description</u>	<b>3</b>
<u>Installing/Mounting</u>	<b>4</b>
<u>Connecting</u>	<b>5</b>
<u>Commissioning</u>	<b>6</b>
<u>Functions</u>	<b>7</b>
<u>Alarm, error, and system messages</u>	<b>8</b>
<u>Service and maintenance</u>	<b>9</b>
<u>Troubleshooting/FAQs</u>	<b>10</b>
<u>Technical data</u>	<b>11</b>
<u>Spare parts/Accessories</u>	<b>12</b>
<u>Menu diagrams</u>	<b>A</b>
<u>Factory settings</u>	<b>B</b>
<u>Approvals/Certificates</u>	<b>C</b>

## Legal information

### Warning notice system

This manual contains notices you have to observe in order to ensure your personal safety, as well as to prevent damage to property. The notices referring to your personal safety are highlighted in the manual by a safety alert symbol, notices referring only to property damage have no safety alert symbol. These notices shown below are graded according to the degree of danger.

 <b>DANGER</b>
indicates that death or severe personal injury <b>will</b> result if proper precautions are not taken.
 <b>WARNING</b>
indicates that death or severe personal injury <b>may</b> result if proper precautions are not taken.
 <b>CAUTION</b>
indicates that minor personal injury can result if proper precautions are not taken.
<b>NOTICE</b>
indicates that property damage can result if proper precautions are not taken.

If more than one degree of danger is present, the warning notice representing the highest degree of danger will be used. A notice warning of injury to persons with a safety alert symbol may also include a warning relating to property damage.

### Qualified Personnel

The product/system described in this documentation may be operated only by **personnel qualified** for the specific task in accordance with the relevant documentation, in particular its warning notices and safety instructions. Qualified personnel are those who, based on their training and experience, are capable of identifying risks and avoiding potential hazards when working with these products/systems.

### Proper use of Siemens products

Note the following:

 <b>WARNING</b>
Siemens products may only be used for the applications described in the catalog and in the relevant technical documentation. If products and components from other manufacturers are used, these must be recommended or approved by Siemens. Proper transport, storage, installation, assembly, commissioning, operation and maintenance are required to ensure that the products operate safely and without any problems. The permissible ambient conditions must be complied with. The information in the relevant documentation must be observed.

### Trademarks

All names identified by ® are registered trademarks of Siemens AG. The remaining trademarks in this publication may be trademarks whose use by third parties for their own purposes could violate the rights of the owner.

### Disclaimer of Liability

We have reviewed the contents of this publication to ensure consistency with the hardware and software described. Since variance cannot be precluded entirely, we cannot guarantee full consistency. However, the information in this publication is reviewed regularly and any necessary corrections are included in subsequent editions.

# Table of contents

<b>1</b>	<b>Introduction.....</b>	<b>7</b>
1.1	Preface.....	7
1.2	Items supplied.....	7
1.3	History.....	8
1.4	Further Information.....	9
<b>2</b>	<b>Safety notes.....</b>	<b>11</b>
2.1	Laws and directives.....	11
2.2	Installation in hazardous location.....	12
<b>3</b>	<b>Description.....</b>	<b>15</b>
3.1	System components.....	15
3.2	Operating principle.....	15
3.3	Applications.....	15
3.4	Features.....	16
3.5	MAG 5000/MAG 6000 versions.....	17
<b>4</b>	<b>Installing/Mounting.....</b>	<b>19</b>
4.1	Introduction.....	19
4.2	Installation conditions.....	20
4.3	MAG 5000/6000 compact.....	22
4.4	Remote installation.....	24
4.5	MAG 5000/6000 CT.....	28
4.5.1	Installing hardware key.....	29
4.5.2	Seal device.....	29
4.5.3	Installation conditions.....	31
4.5.3.1	MI-001.....	31
4.5.3.2	PTB K7.2.....	31
4.6	Turning transmitter/keypad.....	31
<b>5</b>	<b>Connecting.....</b>	<b>35</b>
5.1	Electrical connection.....	36
5.2	Electrical connection PTB K7.2.....	38
5.3	Connection of add-on modules.....	38
<b>6</b>	<b>Commissioning.....</b>	<b>39</b>
6.1	MAG 5000/6000 Blind.....	39
6.2	Local user interface.....	40

6.3	Menu structure .....	41
6.4	Changing password .....	42
6.5	Changing basic settings .....	43
6.6	Changing operator menu setup .....	45
6.7	Changing language .....	46
<b>7</b>	<b>Functions .....</b>	<b>47</b>
7.1	Output settings .....	47
7.2	External input .....	49
7.3	Sensor characteristics .....	49
7.4	Reset mode .....	49
7.5	Service mode .....	51
7.6	MAG 5000 CT and MAG 6000 CT settings .....	51
7.7	MAG 6000 SV .....	52
<b>8</b>	<b>Alarm, error, and system messages .....</b>	<b>53</b>
8.1	Diagnostics .....	53
8.2	List of error numbers .....	55
<b>9</b>	<b>Service and maintenance .....</b>	<b>57</b>
9.1	Transmitter check list .....	57
9.2	Technical support .....	58
9.3	Return procedures .....	59
9.4	Recalibration .....	60
<b>10</b>	<b>Troubleshooting/FAQs .....</b>	<b>61</b>
<b>11</b>	<b>Technical data .....</b>	<b>63</b>
11.1	Technical specifications .....	63
11.2	Accuracy .....	66
11.3	Output characteristics .....	68
11.4	Cable data .....	71
11.5	Cable requirements .....	72
<b>12</b>	<b>Spare parts/Accessories .....</b>	<b>73</b>
12.1	Ordering .....	73
12.2	Accessories .....	73
12.3	Spare parts .....	74
12.4	Sun shield .....	74
<b>A</b>	<b>Menu diagrams .....</b>	<b>75</b>
A.1	Transmitter menu overview .....	75

A.2	Basic settings .....	76
A.3	Current output .....	77
A.4	Digital output - pulse .....	78
A.5	Digital output - frequency .....	78
A.6	Error level.....	78
A.7	Error number .....	79
A.8	Direction/limit.....	79
A.9	Batch .....	79
A.10	External input .....	80
A.11	Sensor characteristics.....	81
A.12	Reset mode.....	82
A.13	Reset mode - MAG 6000 SV .....	83
A.14	Service mode .....	84
A.15	Operator menu setup .....	85
A.16	Product identity .....	86
A.17	Add-on communication module .....	87
A.18	Cleaning .....	87
A.19	MAG 5000/6000 CT menu overview.....	88
A.20	Change password .....	89
<b>B</b>	<b>Factory settings .....</b>	<b>91</b>
B.1	Transmitter factory settings.....	91
B.2	50 Hz Dimension dependent.....	93
B.3	60 Hz Dimension dependent.....	94
B.4	50 Hz Dimension dependent batch and pulse output settings .....	96
B.5	60 Hz Dimension dependent batch and pulse output settings .....	97
<b>C</b>	<b>Approvals/Certificates .....</b>	<b>99</b>
	<b>Index.....</b>	<b>101</b>





# Introduction

## 1.1 Preface

These instructions contain all the information you need for using the device.

The instructions are aimed at persons mechanically installing the device, connecting it electronically, configuring the parameters and commissioning it as well as service and maintenance engineers.

---

### Note

It is the responsibility of the customer that the instructions and directions provided in the manual are read, understood and followed by the relevant personnel before installing the device.

---

## 1.2 Items supplied

- SITRANS F M MAG 5000/6000 transmitter
- Calibration report
- SITRANS F literature CD
- Quick start guide

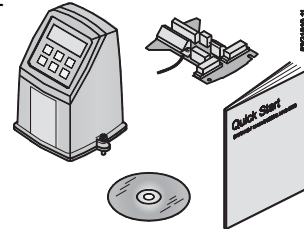

## Inspection

1. Check for mechanical damage due to possible improper handling during shipment. All claims for damage are to be made promptly to the shipper.
2. Make sure the scope of delivery, and the information on the type plate corresponds to the ordering information

### Device identification

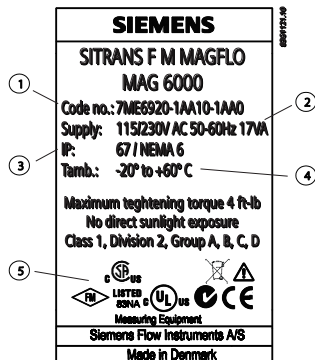

- ① Code number
- ② Power supply
- ③ Enclosure rating
- ④ Ambient temperature
- ⑤ Approvals

Figure 1-1 MAG 5000/6000 nameplate

## 1.3 History

This document describes:

- SITRANS F MAG 5000 and MAG 6000 transmitters (standard version).
- Optional versions:
  - MAG 5000 Blind and MAG 6000 Blind
  - MAG 5000 CT and MAG 6000 CT
  - MAG 6000 SV

## Documentation history

The contents of these instructions are regularly reviewed and corrections are included in subsequent editions. We welcome all suggestions for improvement.

The following table shows the most important changes in the documentation compared to each previous edition.

Edition	Remarks	FW version
01 01/2010	First edition	
02 01/2012		4.04
03 12/2013	<ul style="list-style-type: none"><li>• Customer defined unit</li><li>• Velocity value with unit</li><li>• Operational without SensorProm</li><li>• EPD for 60 Hz mains</li></ul>	4.07

## 1.4 Further Information

### Product information on the Internet

The Operating Instructions are available on the CD-ROM shipped with the device, and on the Internet on the Siemens homepage, where further information on the range of SITRANS F flowmeters may also be found:

Product information on the internet (<http://www.siemens.com/flow>)

### Worldwide contact person

If you need more information or have particular problems not covered sufficiently by these Operating Instructions, get in touch with your contact person. You can find contact information for your local contact person on the Internet:

Local contact person (<http://www.automation.siemens.com/partner>)



 <b>CAUTION</b>
--

Correct, reliable operation of the product requires proper transport, storage, positioning and assembly as well as careful operation and maintenance. Only qualified personnel should install or operate this instrument.
---

---

**Note**

Alterations to the product, including opening or improper repairs of the product, are not permitted.

If this requirement is not observed, the CE mark and the manufacturer's warranty will expire.

---

## 2.1 Laws and directives

### General requirements

Installation of the equipment must comply with national regulations. For example EN 60079-14 for the European Community.

### Instrument safety standards

The device has been tested at the factory, based on the safety requirements. In order to maintain this condition over the expected life of the device the requirements described in these Operating Instructions must be observed.

### Environmental conditions according to IEC 61010-1 (2001)

- Indoor use
- Altitude up to 2000m
- Maximum relative humidity 80% for temperatures up to 31°C (88°F) decreasing linearly up to 50% relative humidity from 40°C (104°F)
- Main supply voltage fluctuations up to ±10% of the nominal voltage (see technical specifications)
- Overvoltage category II
- Pollution degree 2

### CE-marked equipment

The CE mark symbolizes the compliance of the device with the following guidelines:

- EMC-guideline 89/336/EEC
- Low voltage guideline 73/23/EWG
- ATEX Directive 94/9/EG
- CT: (MI-001) Directive 2004/22/EC

## 2.2 Installation in hazardous location

 <b>WARNING</b>
<b>Equipment used in hazardous locations must be Ex-approved and marked accordingly.</b>
It is required that the special conditions for safe use provided in the manual and in the Ex certificate are followed!

### Ex approvals

CSA Class I, Division 2, Groups A, B, C and D. Code T5 for an ambient temperature of +60 °C.

FM Class I, Division 2, Groups A, B, C and D and Class I, Zone 2, Group IIC indoor/outdoor Type IP67 hazardous (classified) locations

### Temperature specifications for Ex use

Temperature class	Ambient temperature [°C]		
	-40 to +40	-40 to +50	-40 to +60
T2	180 (process temperature)	-	-
T3	165 (process temperature)	140 (process temperature)	-
T4	100 (process temperature)	100 (process temperature)	80 (process temperature)
T5	65 (process temperature)	65 (process temperature)	65 (process temperature)
T6	50 (process temperature)	50 (process temperature)	50 (process temperature)

### EX requirements

It is required that:

- Electrical connections are in accordance with Elex V (VO in explosion hazardous areas) and EN60079-14 (Installing Electrical Systems in Explosion Hazardous Areas).
- The protective cover over the power supply is properly installed. For intrinsically safe circuits the connection area can be opened.

- Appropriate cable connectors are used for the output circuits: intrinsically safe: blue, non-intrinsically safe: black
- Sensor and transmitter are connected to the potential equalization. For intrinsically safe output circuits potential equalization must be maintained along the entire connection path.
- Sensor insulation thickness is max. 100mm (only insulated sensors).
- EN50281-1-2 is considered for installation in areas with combustible dust.
- When protective earth (PE) is connected, no potential difference between the protective earth (PE) and the potential equalization (PA) can exist, even during a fault condition.





## Description

### 3.1 System components

A SITRANS F M MAG 5000/6000 flowmeter system includes:

- Transmitter (type SITRANS F M MAG 5000/6000)
- Sensor (types: SITRANS F MAG 1100/1100F/3100/3100 P/5100 W)
- Communication module (optional) (types: HART, PROFIBUS PA/DP, MODBUS RTU RS 485, Foundation Fieldbus H1, Devicenet)
- SENSORPROM memory unit

#### Communication solutions

The SITRANS F USM II range of add on modules, presently including HART, Foundation Fieldbus, MODBUS RTU RS 485, PROFIBUS PA / DP and Devicenet, are all applicable with the SITRANS F M MAG 6000 transmitter.

### 3.2 Operating principle

The transmitters are microprocessor-based with a built-in alphanumeric display in several languages. The flow measuring principle is based on Faraday's law of electromagnetic induction. Magnet coils mounted diametrically on the measuring pipe generate a pulsed electromagnetic field. The liquid flowing through this electromagnetic field induces a voltage.

The transmitters evaluate the signals from the associated electromagnetic sensors, convert the signals into appropriate standard signals such as 4 ... 20 mA, and also fulfil the task of a power supply unit providing the magnet coils with a constant current.

The transmitter consists of a number of function blocks which convert the sensor voltage into flow readings.

### 3.3 Applications

The pulsed DC-powered magnetic flowmeters are suitable for measuring the flow of almost all electrically conductive liquids, pastes, and slurries with max. 40% solids.

The main applications can be found in the following sectors:

- Water and waste water
- Chemical and pharmaceutical industries
- Food & beverage industry
- Mining and cements industries

### 3.4 Features

- Pulp and paper industry
- Steel industry
- Power generation; utility and chilled water industry

## 3.4 Features

### Power supply

2 different types of power supply are available. A 12 ... 24 V AC/DC and a 115 ... 230 V AC switch mode type.

Coil current module generates a pulsating magnetizing current that drives the coils in the sensor. The current is permanently monitored and corrected. Errors or cable faults are registered by the self-monitoring circuit.

Input circuit amplifies the flow-proportional signal from the electrodes. The input impedance is extremely high:  $>10^{14} \Omega$  which allows flow measurements on fluids with conductivities as low as 5  $\mu\text{S/cm}$ . Measuring errors due to cable capacitance are eliminated due to active cable screening.

Digital signal processor converts the analog flow signal to a digital signal and suppresses electrode noise through a digital filter. Inaccuracies in the transmitter as a result of long-term drift and temperature drift are monitored and continuously compensated for via the self-monitoring circuit. The analog to digital conversion takes place in an ultra low noise ASIC with 23 bit signal resolution. This has eliminated the need for range switching. The dynamic range of the transmitter is therefore unsurpassed with a turn down ratio of minimum 3000:1.

### CAN communication

The transmitter operates internally via an internal CAN communication bus. Signals are transferred through a signal conditioner to the display module and to/from internal/external option modules and the dialog module.

### Dialog module

The display unit consists of a 3-line display and a 6-key keypad. The display shows a flow rate or a totalizer value as a primary reading.

### Output module

The output module converts flow data to analog, digital and relay outputs. The outputs are galvanically isolated and can be individually set to suit a particular application.

## 3.5 MAG 5000/MAG 6000 versions

The transmitters are designed in various versions and offer high performance and easy installation, commissioning and maintenance.

### Standard version



The standard version is an IP67 version for compact or remote installation. Its robust design ensures a long lifetime if installed outdoors.

### Blind version



This version carries all the normal MAG 5000/6000 features, except those associated with the display and keypad.

Both current and digital outputs are available.

Factory setting of current output in unit is switched off when delivered.

### CT version



The MAG 5000/6000 CT version is a custody transfer-approved transmitter.

It is approved according to:

- Cold water pattern approval (MAG 5000/6000 CT):
  - OIML R 49
- Cold water pattern approval (MAG 6000 CT only):
  - MI-001
- Hot water pattern approval (MAG 6000 CT only):
- Heat meter pattern approval (MAG 6000 CT only):
  - OIML R 75
- Other media than water (MAG 6000 CT only):
  - OIML R 117

\* Energy metering

- PTB K7.2

### SV version (MAG 6000 only)



This version is identical to the standard MAG 6000 transmitters except for the following additional functions:

- Zero point adjustment
- Adjustable excitation frequency up to 44 Hz

*Description*

---

*3.5 MAG 5000/MAG 6000 versions*

## Installing/Mounting

### 4.1 Introduction

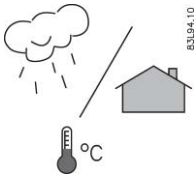

- SITRANS F flowmeters are suitable for indoor and outdoor installations.

<b>WARNING</b>
<b>Installation in hazardous location</b> Special requirements apply to the location and interconnection of sensor and transmitter. See "Installation in hazardous area"

This chapter describes how to install the flowmeter in the compact version as well as in the remote version.

The transmitter is delivered ready for mounting on the sensor. The transmitter is delivered with a compression plate ready for mounting on the sensor. No further assembling is necessary.

The transmitter can be installed either compact on the sensor or remote.

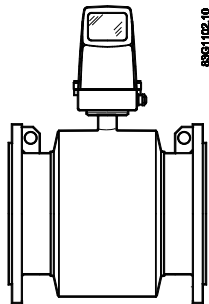

Figure 4-1 Compact installation

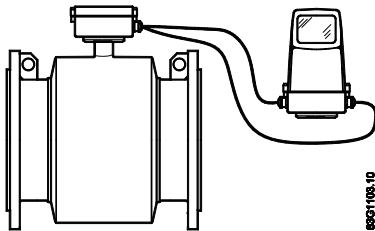

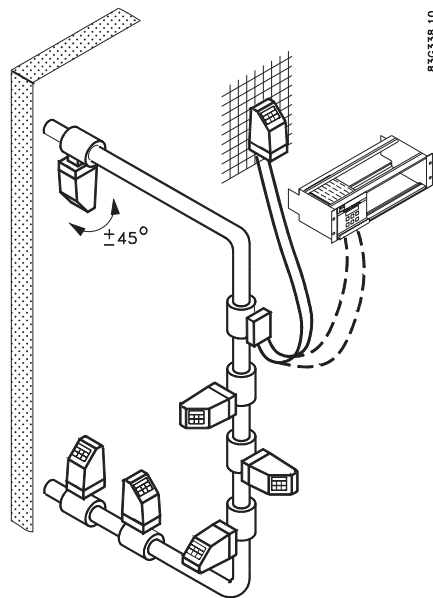

Figure 4-2 Remote installation

 <b>CAUTION</b>
See Cable requirements (Page 72) before installing transmitter

## 4.2 Installation conditions

Reading and operating the flowmeter is possible under almost any installation conditions because the display can be oriented in relation to the sensor. To ensure optimum flow measurement, attention should be paid to the following:



### Vibrations

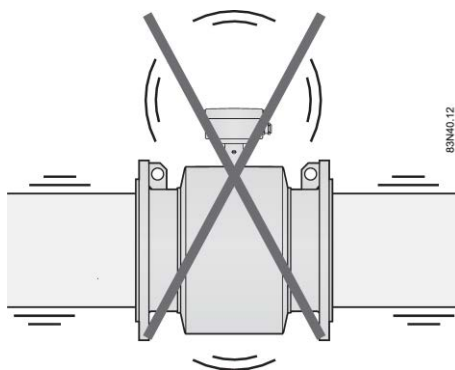
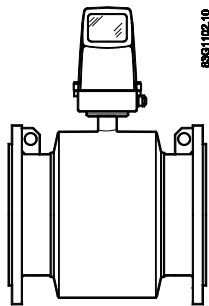

Figure 4-3 Avoid strong vibrations

### Compact installation



Medium temperature must be in accordance with the graphs showing max. ambient temperature as a function of medium temperature.

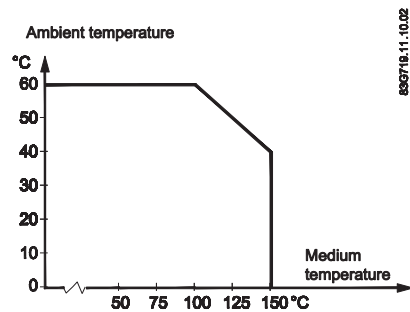

Figure 4-4 Standard, blind and SV versions

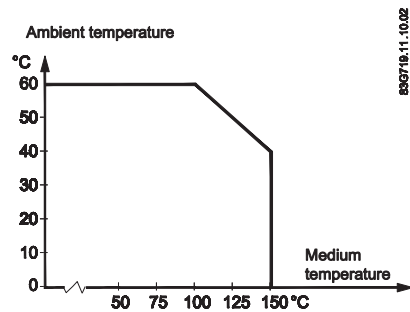
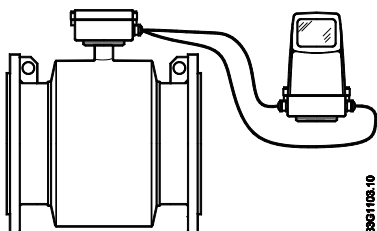

Figure 4-5 CT version

### Remote installation



Cable length and type (as described in Cable requirements (Page 72)) must be used.

For installation conditions for sensors, see respective sensor operating instructions.

### 4.3 MAG 5000/6000 compact

#### Install MAG 5000 / MAG 6000 compact version

1. Remove and discard terminal box lid of sensor.

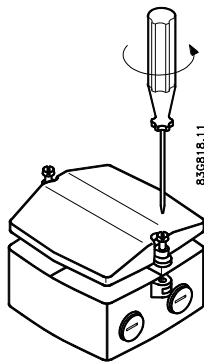

2. Ensure SENSORPROM® memory unit is installed.
3. Fit M20 or ½" NPT cable glands for supply and output cables.
4. Unplug the two black plug assemblies for coil and electrode cables in terminal box.
5. Connect earth wire from connection board to bottom of terminal box.
6. Connect 2-pin connector and 3-pin connector as shown to their corresponding terminal numbers on connection board as shown in Electrical connection (Page 36).

---

#### Note

System will not register flow if black plugs are not connected to connection board.

---

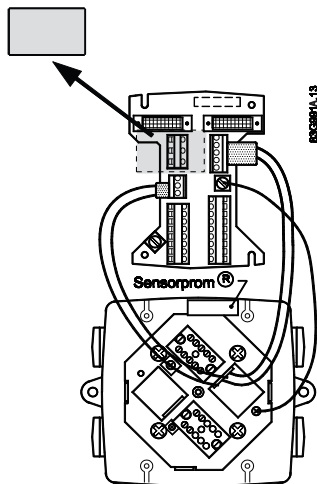

7. Fit supply and output cables through cable glands and connect to connection plate as shown in Electrical connection (Page 36).



8. Mount connection plate in terminal box.

**Note**

Check that your connection board lines up with SENSORPROM® unit, if not, move SENSORPROM® unit to the other side of terminal box.

SENSORPROM® memory unit connections will be established automatically when connection plate is mounted in terminal box.

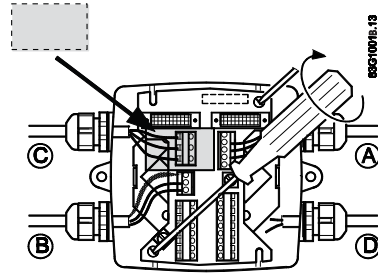

9. Tighten cable glands to obtain optimum sealing.
10. Mount transmitter on terminal box.

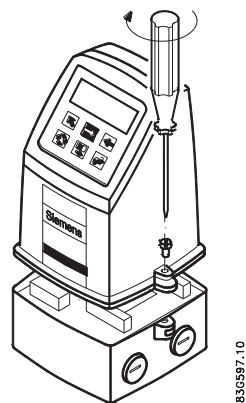

11. Transmitter is ready to be powered up.

**NOTICE**

Exposing transmitter to direct sunlight may increase operating temperature above its specified limit, and decrease display visibility.

A sunshield is available as accessory.

## 4.4 Remote installation

### At sensor

1. Remove terminal box lid.

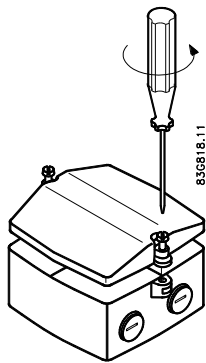

2. Remove SENSORPROM® unit from sensor terminal box and mount it in terminal box of wall mounting unit.

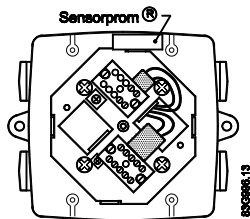

3. Fit M20 or ½" NPT cable glands for cables.

4. Fit and connect electrode (1) and coil (2) cables as shown in Electrical connection (Page 36).

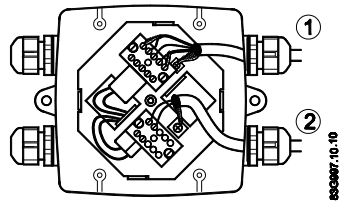

**Note**

Unscreened cable ends must be kept as short as possible.

Electrode cable and coil cable must be kept separate to prevent interference.

5. Tighten cable glands well to obtain optimum sealing.

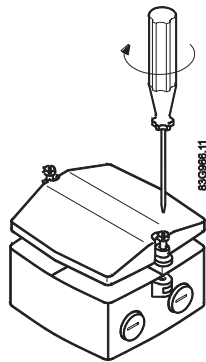

**⚠ WARNING**

Mount terminal box lid before power up.

### Wall mounting

1. Mount bracket on a wall or on a horizontal or a vertical pipe using ordinary hose clips or duct straps.

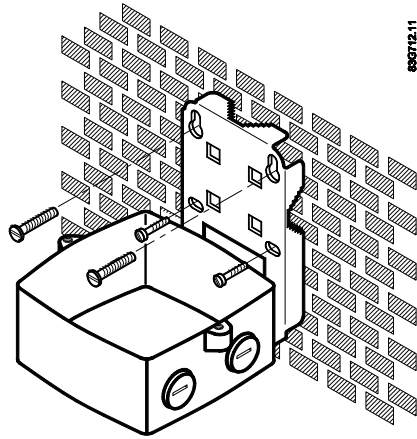

Figure 4-6 Wall mounting

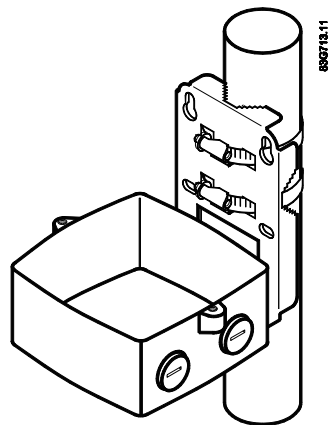

Figure 4-7 Pipe mounting - vertical

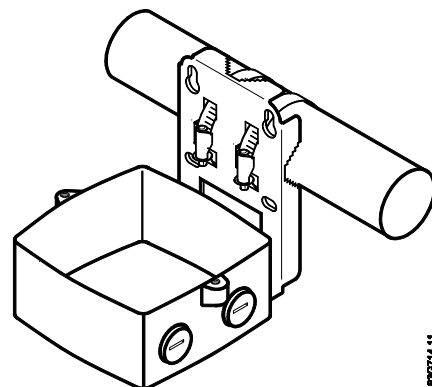
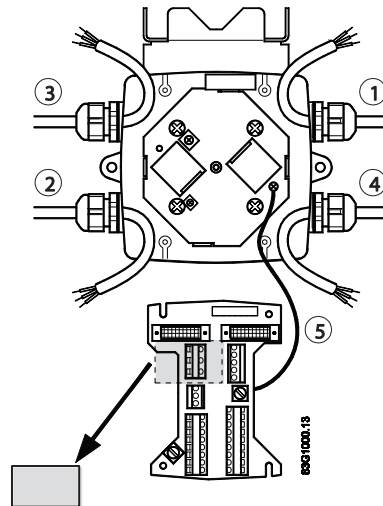

Figure 4-8 Pipe mounting - horizontal

2. Ensure that correct SENSORPROM® memory unit is mounted in wall/pipe mounting unit.

3. Fit M20 or ½" NPT cable glands for cables from bottom or sides of terminal box.
4. Mount earth wire in bottom of terminal box.



- ① Connect electrode cable
- ② Connect coil cable - keep separate from electrode cable
- ③ Connect power supply
- ④ Connect output cable
- ⑤ Connect PE (ground) wire

5. Mount connection plate in terminal box.

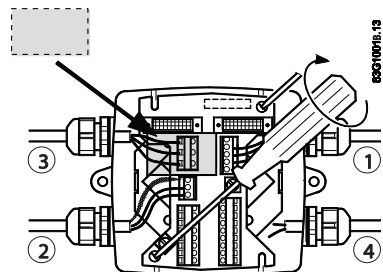

- ① Electrode cable
- ② Coil cable
- ③ Power supply
- ④ Output cable

6. Fit coil, electrode, supply and output cables through cable glands and connect to connection plate as shown in Electrical connection (Page 36).
7. Fix connection plate with the two diagonally opposite screws.

- 8. Tighten cable glands to obtain optimum sealing.

<b>⚠ CAUTION</b>
When remote mounted, power supply PE wire must be connected to PE terminal (⊕). Coil cable shield must be connected to SHIELD terminal.

- 9. Mount transmitter on terminal box.

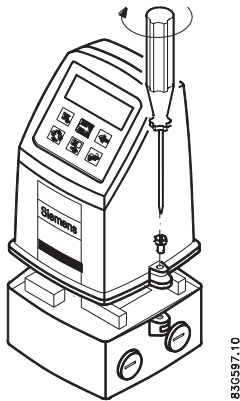

- 10. Transmitter is ready to be powered up.

<b>NOTICE</b>
Exposing the transmitter to direct sunlight may increase the operating temperature above its specified limit, and decrease display visibility. A sun shield is available as accessory.

## 4.5 MAG 5000/6000 CT

To ensure that the settings of this custody transfer-approved MAG 5000/6000 CT transmitter are not changed, it is necessary to install a hardware key to lock the software functions and to seal the device.

MAG 6000 CT is installed like a Standard MAG 6000 except for the final sealing.

Calibration sealing has been carried out at calibration.

## 4.5.1 Installing hardware key

### Use hardware key on non-verified transmitter

1. Mount hardware key on transmitter connection plate during setting of primary operating parameters such as  $Q_{max.}$ , low-flow cut-off, units, approvals, etc. in connection with commissioning or calibration. See setup menus in appendix menu diagrams.

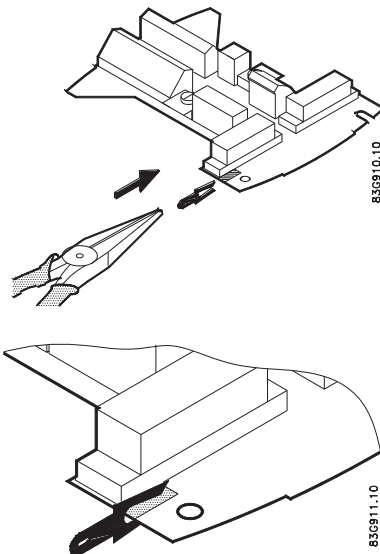

2. Remove hardware key after setting up and calibrating unit.

This locks the menu structure and the selected settings.

---

#### Note

#### Hardware key function

Setting of primary operating parameters is blocked during normal operation.

When key is mounted, access to all menu items is gained. When key is removed, primary settings are blocked in accordance with requirements in authorisation.

---

## 4.5.2 Seal device

### Seal transmitter

 <b>CAUTION</b>
Seal transmitter to prevent unauthorized access.

1. Seal connection plate to prevent access to SENSORPROM® memory unit as shown below. 1 indicates sealing locations.

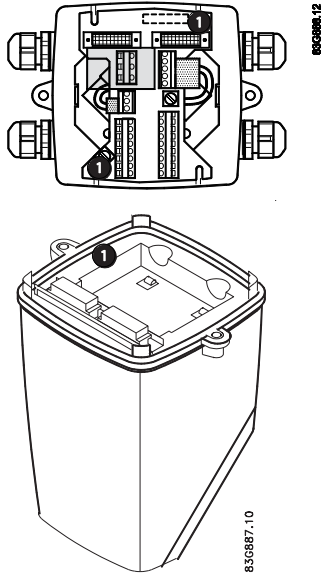

2. Drill through marked drilling holes in terminal box and transmitter/lid. Seal transmitter externally as shown below.

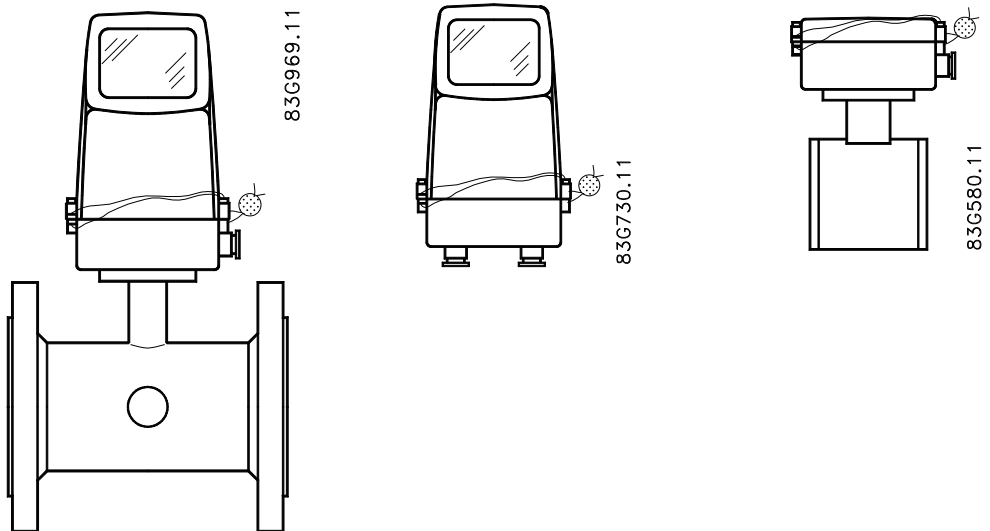



### 4.5.3 Installation conditions

#### 4.5.3.1 MI-001

MAG 5000/6000 CT together with MAG 5100W (7ME652) are approved for Mi-001 under the following installation conditions.

- DN 50 to 300 mm (2" to 12")
- Horizontal installation
- Compact or remote with max. 3 m cable
- Power supply 115/230 V AC

Other restrictions may apply (see certificate).

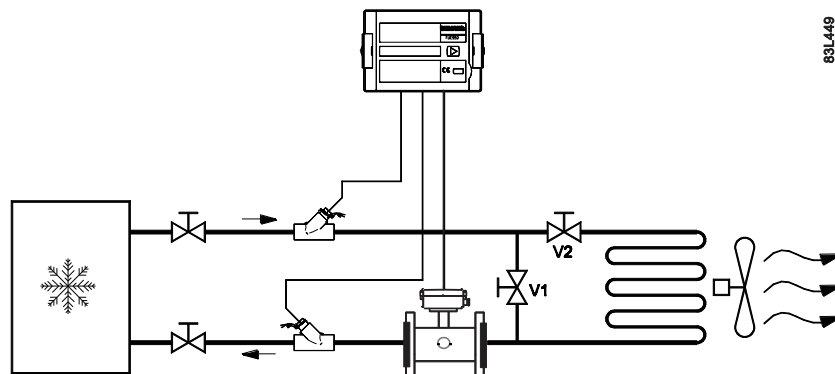

#### 4.5.3.2 PTB K7.2

MAG 5000/6000 CT together with MAG 5100W (7ME652) are approved for PTB K7.2 under the following installation conditions.

##### **SITRANS F M MAG 5100 W with MAG 5000/6000CT**

- DN 50 to 300 mm (2" to 12")
- Horizontal installation
- Compact or remote with max. 10 m (33 ft.) cable

Other restrictions may apply (see certificate 22.76/10.02)

\*\*insert installation conditions as pasted

## 4.6 Turning transmitter/keypad

It is possible to alter the standard assembly, e.g. to turn transmitter or keypad.

### Transmitter

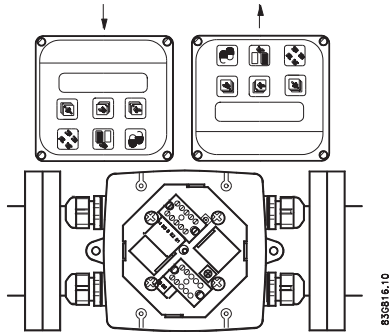

Figure 4-9 Transmitter can be mounted with its front in either direction indicated by the arrows without turning terminal box

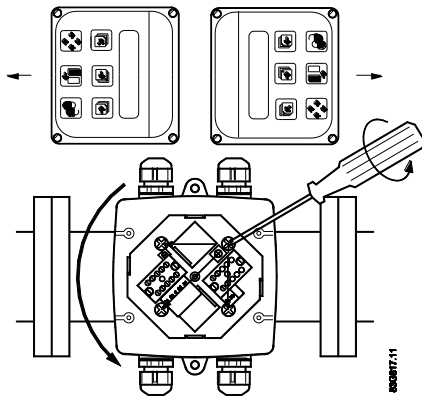
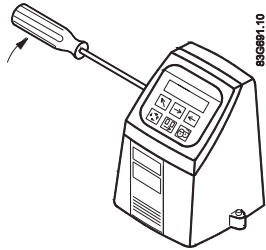

Figure 4-10 Terminal box can be rotated  $\pm 90^\circ$  in order to optimize viewing angle of transmitter display/keypad

1. Unscrew the four screws in bottom of terminal box.
2. Turn terminal box to required position.
3. Retighten screws firmly.

## Keypad

1. Remove outer frame using a screwdriver.



2. Loosen the four screws retaining keypad.

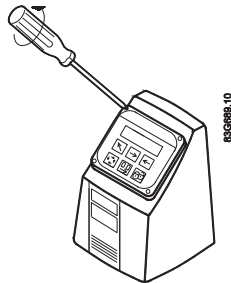

3. Withdraw keypad and turn it to required orientation.

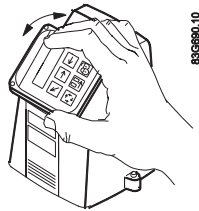

4.6 Turning transmitter/keypad

4. Tighten the four screws until a mechanical stop is felt in order to obtain IP67 enclosure.

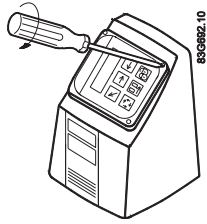

5. Snaplock outer frame onto keypad (click).

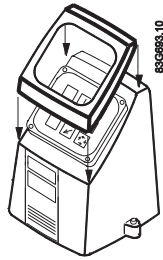

 **WARNING**

**Mains supply from building installation Class II**

A switch or circuit breaker (Max. 15 A) must be installed in close proximity to the equipment and within easy reach of the operator. It must be marked as the disconnecting device for the equipment.

 **WARNING**

**Protective conductor terminal**

The required cable is min. AGW16 or 1.5 Cu.

 **WARNING**

**Wire insulation**

The insulation between the connected mains supply and 24 V AC/DC supply for the flowmeter must at least be rated with double or reinforced insulation at mains voltage.

For field wiring installation: Ensure that the **National Installation Code** of the country in which the flowmeters are installed is met.

**Note**

**National installation code**

Observe country specific installation directives for field wiring.

# 5.1 Electrical connection

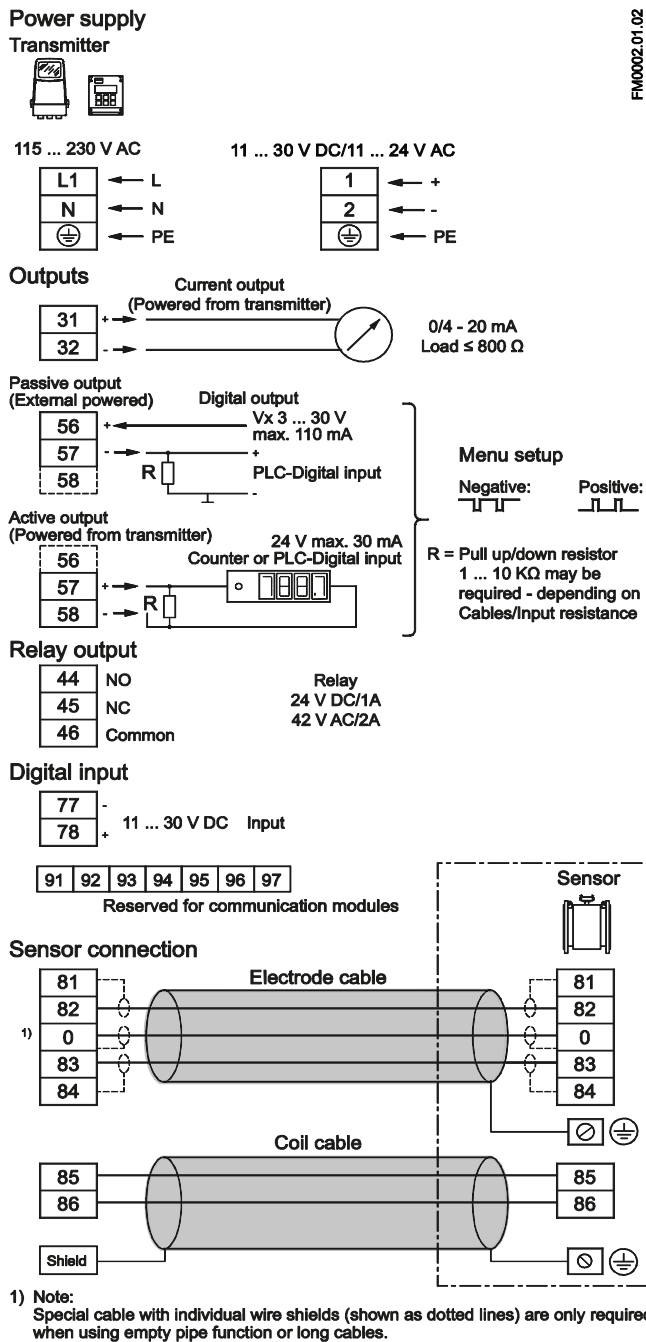

Figure 5-1 Wiring diagram

**Note**

Terminals 81 and 84 are only to be connected if special electrode cable with double screening is used, e.g. when empty pipe function or long cables are used.

**Mains supply**

Mains supply 115 ... 230 V AC from building installation Class II.

**Note**

For DC installations it is recommend to install an under voltage relay or protection circuit in the application where there is a risk of low power supply below the specifications for more than 10 minutes.

**⚠ WARNING****Grounding**

Connect mains protective earth wire to PE terminal in accordance with diagram (due to class 1 power supply).

**Mechanical counter**

Connect a 1000  $\mu$ F capacitor (capacitor+ to terminal 56 and capacitor- to terminal 58) if a mechanical counter is connected to terminals 57 and 58 (active output).

**Output cables**

Use screened cables if long cables are used in noisy environments.

**Digital output**

If internal resistance of a load exceeds 10 k $\Omega$ , connect an external 10 k $\Omega$  load resistor in parallel to this load.

**⚠ WARNING****Intrinsically safe terminals**

**Always** ensure that distance between cables/wires is **minimum 50 mm** in order to avoid that wires/terminals of intrinsically safe circuits get into contact with wires of other cables.

Fasten cables/wires in a way that they **cannot** get into contact with each other, not even in case of an error. Keep wire ends as short as possible.

## 5.2 Electrical connection PTB K7.2

Additional Electrical connection for PTB K7.2 approved MAG5000/6000 with MAG5100W (7ME652)

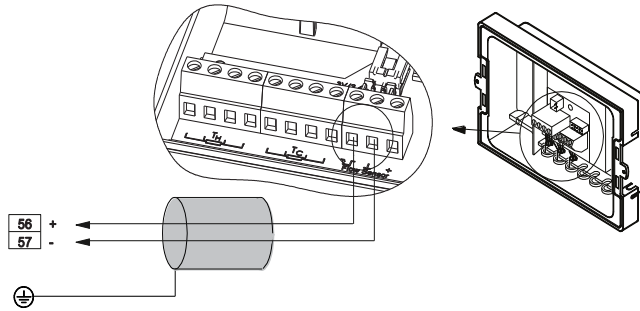

## 5.3 Connection of add-on modules

When the add-on module has been installed, the electrical connections are available on terminal rows 91-97.

### For more information

Refer to the relevant BUS communication Quick Start or Operating Instructions available at the SITRANS F literature CD or on the internet, at : [www.siemens.com/flowdocumentation](http://www.siemens.com/flowdocumentation) ([www.siemens.com/flowdocumentation](http://www.siemens.com/flowdocumentation)).



# Commissioning

In this chapter it is described how to commission the device via the local user interface (LUI). The display is described in details in section Local user interface (Page 40).

Furthermore, the following functions are described in details:

- Changing password (Page 42)
- Changing basic settings (Page 43)
- Changing operator menu setup (Page 45)
- Changing language (Page 46)

Detailed diagrams concerning the specific menu are shown in appendix menu diagrams.

For factory settings, see Factory settings.

## 6.1 MAG 5000/6000 Blind

---

### Note

Does not have a display. All factory settings will be uploaded from the SENSORPROM® unit after power-up.

---

For sensor dependent factory settings, see Appendix B.

### Changing settings

If other settings are required, a standard transmitter with display and similar power supply can be used.

1. Unscrew and remove MAG 5000/6000 Blind.
2. Mount standard MAG 5000/6000 transmitter.
3. Change required settings via display and keypad.

All changed data will be stored in SENSORPROM® memory unit.

4. Remove standard transmitter and remount Blind transmitter.
5. Fasten screws holding transmitter.

New settings stored in SENSORPROM® memory unit will be uploaded in blind transmitter.

## 6.2 Local user interface

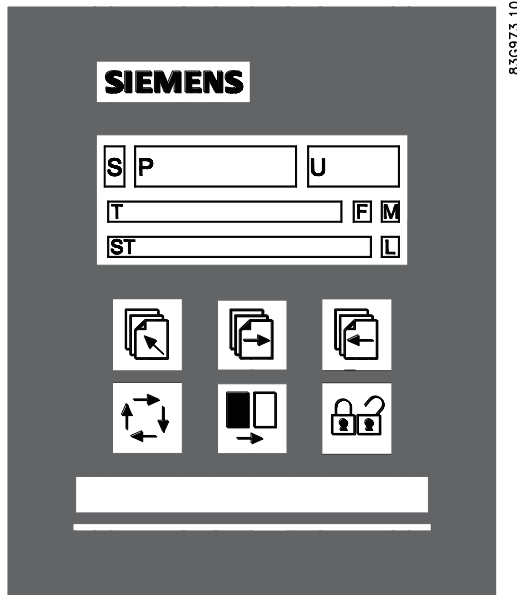

836973.10





- S Sign field
- P Primary field for numeric value flow rate, Totalizer 1 or Totalizer 2)
- U Unit field
- T Title line with individual information according to operator or setup menu selected.
- ST Subtitle line which will either add information to the title line or keep individual information independent of the title line.
- F Alarm field. Two flashing triangles will appear in case of a fault condition.
- M Mode field
- L Lock field

Figure 6-1 Local User Interface

### Mode field symbols







	Communication mode		Language mode		Sensor characteristics
	Service mode		Basic settings		Reset mode
	Operator menu		Output		Operator-active
	Product identity		External input		Operator-inactive

## Lock field symbols

	Ready for change		Access to submenu
	Value locked		RESET MODE: Zero setting of totalizers and initialization of setting

## Keypad



The keypad is used to set the flowmeter. The keys function as follows:

TOP UP KEY		This key (when held for 2 sec.) is used to switch between operator menu and setup menu. In transmitter setup menu, a short press will cause a return to previous level.
FORWARD KEY		This key is used to step forward through the menus. It is the only key normally used by the operator.
BACKWARD KEY		This key is used to step backwards through the menus.
CHANGE KEY		With this key settings or numerical values are changed.
SELECT KEY		With this key figures to be changed are selected.
LOCK/UNLOCK KEY		This key enables the operator to change settings and it gives access to submenus.

## 6.3 Menu structure

The menu is built up of two parts. An **operator menu** and a **setup menu**, see also overview diagrams MAG 5000/6000 and MAG 5000/6000 CT.

### Operator menu

The operator menu is for daily operation. It is customized in the operator menu setup. The transmitter always starts up in operator menu No. 1. The forward  and the backward keys  are used to step through the operator menus.



### Setup menu

The setup menu is for commissioning and service only. Access to the setup menu is gained by pressing the top up key  for 2 seconds. The setup menu operates in two modes:

- View mode
- Setup mode

**View mode** is a read-only mode. The pre-selected settings can only be scanned.









**Setup mode** is a read and write mode. The pre-selected settings can be scanned and changed. Access to the setup mode is password-protected. The factory set password is 1000.

Access to a submenu in the setup menu is gained by pressing the lock key . Press the top up key  briefly to return to the previous menu. Press longer (2 sec.) to exit the setup menu and return to operator menu No. 1.

## 6.4 Changing password

The setup menu is password-protected in order to ensure that only authorized personnel can make any changes in transmitter settings.



Change password as follows:

1. Press top up key  for 2 sec.
2. Enter password.
3. Use forward key  or backward key  to reach password menu.
4. Press lock/unlock key  to unlock password.
5. Use select key  and change key  to change password.
6. Press lock/unlock key  to confirm new password.
7. Press top up key  two times to exit setup mode.

See change password diagram.

The factory-set password is 1000, but it can be changed to any value between 1000 and 9999.

Factory setting of password can be re-established as follows:

1. Switch off power supply.
2. While pressing top up key  - switch on power supply.
3. Release top up key  after 10 sec.

## 6.5 Changing basic settings

In the basic settings menu it is possible to set the following parameters:

Parameter	Description
Main frequency	Selection of main power supply frequency corresponding to the country in which the flowmeter is installed (e.g. 60 Hz in America).
Flow direction	Selection of correct flow direction in pipe.
Customer units	Setting of user defined volume and time units.
Q <sub>max</sub>	Setting of measuring range, analog outputs and frequency output. Also individual dimension-dependent setting of value, decimal point, unit and time.
Q <sub>max</sub> 2	Setting of measuring range, analog outputs and frequency output. Also individual dimension-dependent setting of value, decimal point, unit and time. This menu is only visible if chosen as external digital input.
Totalizer	Setting of unit and decimal point.
Low flow cut-off	Setting of a percentage of selected Q <sub>max</sub> . This filters noise in installation reducing fluctuations in display and all outputs.
Empty pipe cut-off	When set to "On" the alarm will indicate when sensor is running empty. All readings, display and outputs, will indicate zero.
Velocity unit	Setting of velocity unit per time unit
Error level	Selecting error level at which flowmeter will detect an error.









### Note

Totalizer 2 is not visible when batch is selected as digital output.

### Note

Q<sub>max</sub> 2 is visible only when chosen as digital input.

Change basic settings as follows:

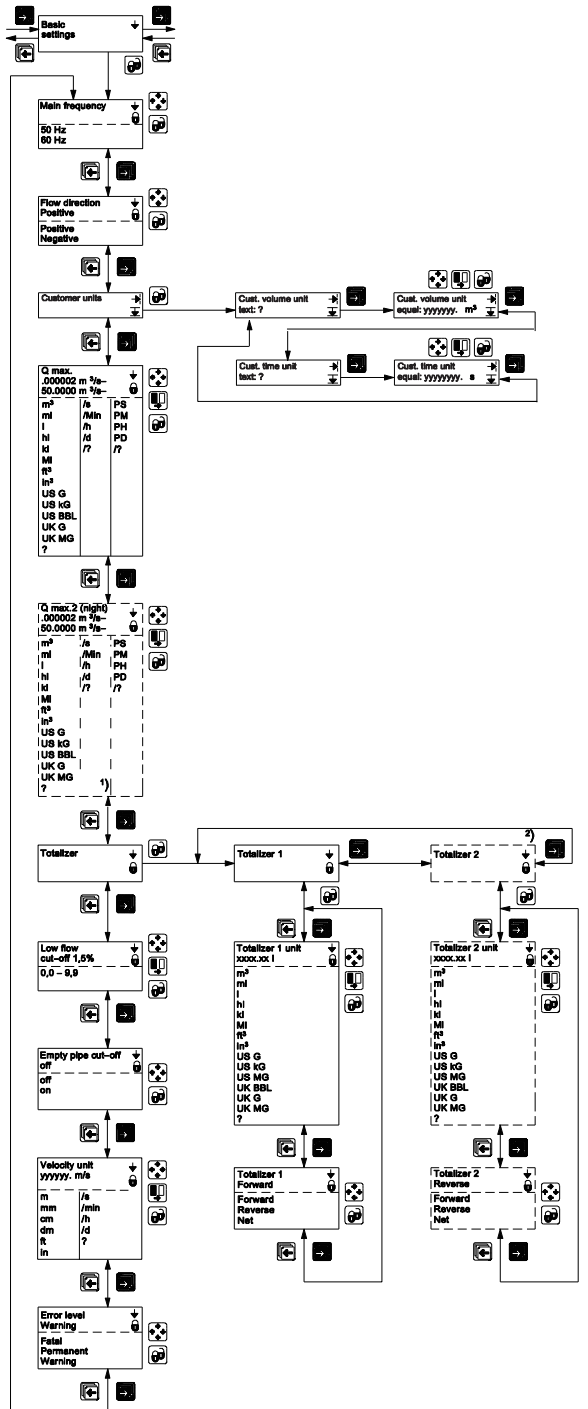

1. Press top up key  for 2 sec.
2. Enter password.
3. Use forward key  to reach basic settings menu.
4. Press lock/unlock key  to unlock settings.
5. Use forward key  or backward key  to reach relevant menu.
6. Press lock/unlock key  to unlock settings.
7. Use select key  and change key  to change settings.
8. Press lock/unlock key  to confirm new settings.

9. Repeat steps 5-8 to change other settings.
10. Press top up key  two times to exit setup mode.





Decimal point can be positioned and units set individually for flow rate in totalizer 1 and totalizer 2.

### Changing decimal point position

1. Enter the respective totalizer menu.
2. Use select key  to position cursor below decimal point.
3. Use change key  to move decimal point to requested position.

### Changing units



1. Use select key  to position cursor below unit.
2. Press change key  until requested unit is displayed.

## 6.6 Changing operator menu setup



In the operator menu the menus required for daily operation of the flowmeter are shown. It is possible to hide and change some of the menus in the operator menu. This is done in the operator menu setup menu, see operator menu setup diagram.

### Customizing menus in operator menu

To customize the menus in the operator menu perform the following steps:

1. Press top up key  for 2 sec.
2. Enter password.
3. Use forward key  or backward key  to reach operator menu.

### Changing text in line 1

1. Press lock/unlock key  to unlock setting.
2. Use change key  to select desired text.
3. Press lock/unlock key  to confirm selected text.





---



#### Note

If "Text" is selected in line 2, this line functions as a heading for the value shown in line 3. Otherwise it shows the actual value of the reading selected.





---

### Enabling two readings

1. Use forward key  to reach requested menu.
2. Press lock/unlock key  to unlock setting.
3. Use select key  to move cursor to upper line.
4. Use change key  to select requested reading.
5. Press lock/unlock key  to confirm selection.

6. Use select key  to move cursor to line 3.
7. Use change key  to select desired setting.
8. Press lock/unlock key  to confirm new setting.
9. Repeat steps 1-8 for each requested menu.







### Showing/hiding menus in operator menu

1. Use forward key  to reach requested menu.
2. Press lock/unlock key  to unlock setting.
3. Use select key  to move cursor to  $\sqrt{\quad}$  /  $\div$  symbol.
4. Press change key  to select visible ( $\sqrt{\quad}$ ) or hidden ( $\div$ ).
5. Press lock/unlock key  to confirm new setting.

## 6.7 Changing language

It is possible to change language in transmitter. Default language is English, but it can be changed to various other languages.

Change language as follows:

1. Press top up key  for 2 sec.
2. Enter password.
3. Use forward key  or backward key  to reach language menu.
4. Press lock/unlock key  to unlock language.
5. Use change key  to select desired language.
6. Press lock/unlock key  to confirm new language.
7. Press top up key  two times to exit setup mode.

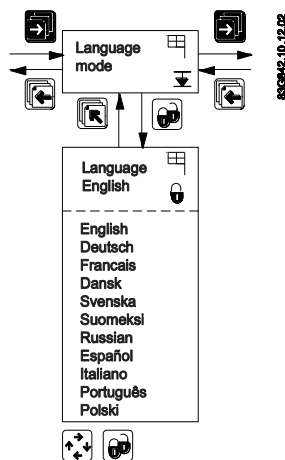



## Functions

This chapter describes the various menus of the transmitter in details. The menu diagrams are shown in appendix menu diagrams.

### 7.1 Output settings

Three outputs are available:

- Current output (range and time constant); terminals 31 and 32.
- Digital output (pulse, frequency, error, limit, or batch settings); terminals 56, 57, and 58.
- Relay output (error, limit, and batch settings); terminals 44, 45, and 46.

#### Current output

In the current output menu it is possible to select current output direction, range and time constant, see also Current output menu diagram.

If current output "4-20 mA + Alarm" is selected, then alarm level and alarm differentiation may also be defined.

"Alarm level" defines if an alarm should be above 21 mA "High" or below 3.6 mA "Low".

"Alarm diff." defines whether or not the alarm should vary according to selected error level. Error level "Fatal". "Permanent" or "Warning" is selected in "Basic settings".

If Alarm differentiation is set to "Yes", depending on the Alarm level setting, the current output will show:

Alarm level	Output / Error level		
	Fatal	Permanent	Warning
Low	1.3 mA	2 mA	3 mA
High	23 mA	22 mA	21.5 mA

If Alarm differentiation is set to "No", depending on the Alarm level setting, the current output will show:

Alarm level	Output
Low	3.5 mA
High	22.6 mA

For setting of error level, see Error level menu diagram.

If current output is not used, it must be set to "Off".

### Digital output

Digital output can be used to configure various settings:

- Pulse (volume/pulse, pulse output, pulse width, pulse polarity, and time constant), see pulse menu diagram.
- Frequency (frequency output, max frequency, and time constant), see frequency menu diagram.
- Error settings (level and number), see error level menu diagram and error number menu diagram.
- Limit settings (number of setpoints, setpoint settings, and hysteresis), see direction/limit menu diagram.
- Batch settings (quantity, time and counter settings, and time constant), see batch menu diagram.

---

**Note**

**Batch settings**

Only MAG 6000.

Not available in MAG 5000, MAG 5000 CT and MAG 6000 CT.

---

**Note**

When relay is set to batch function, pulse/frequency is not available on digital output.

---

### Relay outputs

Relay output can be used to configure various settings:

- Error settings (level and number), see error level menu diagram and error number menu diagram.
- Limit settings (number of setpoints, setpoint settings, and hysteresis), see direction/limit menu diagram.
- Batch settings (quantity, time and counter settings, and time constant), see batch menu diagram.
- Cleaning (cycle time), see cleaning menu diagram.

---

**Note**

**Batch settings**

Only MAG 6000.

Not available in MAG 5000, MAG 5000 CT and MAG 6000 CT.

---

**Note**

**Cleaning**

If a cleaning unit is installed together with transmitter, relay output must **always** be used to operate this unit. It cannot be used for other purposes.

---

## 7.2 External input

By applying 11 ... 30 V DC to terminals 77 and 78, it is possible to perform:

- Batch control (start, stop, hold/continue)
- Reset totalizer
- Force/freeze output
- $Q_{\max}$  2 (night)

See external input menu diagram.

---

### Note

#### Batch settings

Only MAG 6000.

Not available in MAG 5000, MAG 5000 CT and MAG 6000 CT.

---

### Note

#### Manual cleaning

If the digital input is used for manual cleaning, the relay output also automatically changes to "cleaning".

---

## 7.3 Sensor characteristics

The sensor characteristics menu shows:







- If a SENSORPROM® is installed or not.
- Suppress error P 40 (SENSORPROM® not installed)
- Sensor size.
- Calibration factor.
- Correction factor.
- Excitation.

See also sensor characteristics menu diagram.

## 7.4 Reset mode

The reset mode is used for resetting totalizers/counters or for restoring MAG 5000/6000 to its factory settings.

## Resetting

1. Press top up key  for 2 sec.
2. Enter password.
3. Use forward key  or backward key  to reach reset mode menu.
4. Press lock/unlock key  to enter reset menu.
5. Press forward key  to reach totalizer/counter to be reset or default setting menu.
6. Press lock/unlock key  to start resetting.

If restoring of factory settings is required:









1. Press lock/unlock key  again to confirm destruction of customized settings.

See also reset menu diagram.







## Zero point adjustment (MAG 6000 SV only)

### Auto adjustment

Before auto zero point adjustment is carried out ensure that valves to and from flowmeter are completely closed and that flow velocity in sensor is zero.

1. Press top up key  for 2 sec.
2. Enter password.
3. Use forward key  or backward key  to reach reset mode menu.
4. Press lock/unlock key  to enter reset menu.
5. Press forward key  to reach zero adjust menu.
6. Press lock/unlock key  to enter the menu.
7. Use change key  to select "auto".
8. Press forward key  to view actual offset (lower line in display). Value will be zero after adjustment has been performed.
9. Press lock/unlock key  to start adjustment.

### Manual adjustment.

1. Press top up key  for 2 sec.
2. Enter password.
3. Use forward key  or backward key  to reach reset mode menu.
4. Press lock/unlock key  to enter reset menu.
5. Press forward key  to reach zero adjust menu.
6. Press lock/unlock key  to enter the menu.
7. Use change key  to select "manual".

8. Press forward key  and then select key  and change key  to key in offset value.
9. Press lock/unlock key  to start adjustment.

Zero point can be adjusted manually in range -1.000 ... +1.000 m<sup>3</sup>/s. If value outside this range is keyed in, zero point adjustment will not be implemented.

See also reset mode menu diagram (MAG 6000 SV).

## 7.5 Service mode

All outputs of the transmitter can be forced-controlled in the service mode menu, see also service mode menu diagram.

Here it is possible to check whether e.g. the current output is functioning.

Error pending and status log lists are also accessible from this menu and the operating time (in days) can be read.

The forced control is cut off and all previous settings are reinitialized the moment the service mode is left by pressing top up key .

## 7.6 MAG 5000 CT and MAG 6000 CT settings

### Internal totalizers

Depending on the type of approval it is possible to reset the internal totalizers. The type of approval is selected in the reset menu with the hardware key mounted. It is possible to choose between:

- Hot/cold water
- Other liquids

Resetting of totalizers by electrical input is not possible.

#### Hot/cold water

- Totalizer 1 is allocated to forward flow (cannot be reset)
- Totalizer 2 is allocated to reverse flow (cannot be reset)

#### Other liquids

Both totalizer 1 and totalizer 2 are allocated to measure the net flow, i.e. any reverse flow will make the totalizers count backwards.

- Totalizer 1 cannot be reset.
- Totalizer 2 can be reset if the flow velocity in the meter pipe is <0.25 m/s. When the totalizer is reset, the pulse output register will also be reset.

### Output

- When choosing hot water, changing the output settings is not allowed and the output setting menus are not shown in display.
- When choosing cold water or other liquids, all output settings can be changed.

## 7.7 MAG 6000 SV

### Excitation frequency

The MAG 6000 SV excitation frequency can be changed in sensor characteristics menu to one of the following frequencies:

- 1  $\frac{9}{16}$  Hz
- 3  $\frac{1}{8}$  Hz
- 6  $\frac{1}{4}$  Hz
- 12  $\frac{1}{2}$  Hz
- 25 Hz
- 44 Hz

---

#### Note

Calibration has been made with the frequency stored in SENSORPROM® memory unit. A change in excitation frequency is not recommended and will always mean decreased measuring accuracy. In some instances, however, it may be necessary to change frequency due to pulsating flow from piston pumps or other resonance frequencies from surroundings.

---

It is highly recommended to carry out a External input (Page 49) after changing the excitation frequency as the offset is affected by the frequency selected. When this is done, the decrease in measuring accuracy can be kept below 1% o.r.

A too high frequency for the sensor used will cause a coil current alarm indication.

# Alarm, error, and system messages

## 8.1 Diagnostics

### Error system

Transmitter system is equipped with an error and status log system with 4 groups of information.

(I) Information - system will continue to measure as normal, relay and current outputs will not be affected.

(W) Warning - system will continue to measure, but an event that may cause a system malfunction and require operator attention has occurred. The cause of the error may disappear on its own.

(P) Permanent error - may cause malfunction in the application and operator attention is required.

(F) Fatal error - is essential for the operation of the flowmeter. Immediate operator attention is required.

Two menus are available in service and operator menus for registration of information and errors.

- Error pending
- Status log

---

#### Note

##### Registration of errors in different modes

- In setup mode (local dialog) errors are entered only to Error pending list and not to Error log list, and not registered on physical outputs (current or relay).
  - In service mode errors are entered to both Error pending and Error log lists, but not registered on physical outputs (current or relay).
- 

#### Note

##### Power-off

Both error pending and status logs are reset at power-off.

---

### Error pending

The first 9 pending errors are stored in the error pending list. When the error is corrected, it is removed from the error pending list.

The acceptance level for "error pending" can be individually configured to a particular application.

The acceptance level is set in the basic settings menu (Page 43).

**Acceptance levels**

The following three acceptance levels are selectable.

- Fatal error: Only fatal errors are registered as errors
- Permanent error: Permanent and fatal errors are registered as errors
- Warning (Default value): Warnings, permanent and fatal errors are registered as errors

Error information is displayed in title and subtitle lines, see display layout (Page 40). Title line will show time since occurrence of error in days, hours and minutes. Subtitle line will flash between an error text and a remedy text. Error text will indicate type of error (I, W, P or F), error number, and error text. Remedy text will inform operator of action to take to remove error.

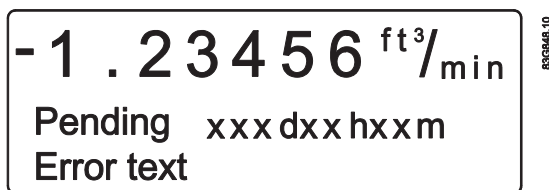

**Status log**

The latest 9 errors are stored in the status log. Errors are stored in the status log for 180 days, even if they are corrected.

**Alarm field**

The alarm field on the display will always flash when an error is pending.

**Error output**

The digital and relay output can be activated individually error by error (error level). The relay output is default selected to error level. An output can also be selected to activate on a single error number.

The alarm field, error output and error pending always operate together.

**Operator menu**

Error pending and status log are as default enabled (✓) in the operator menu.



## 8.2 List of error numbers

Error No.	Error text Remedy text	Comment	Output status	Input status
1	<i>I1 - Power on</i> OK	Device powered on	Active	Active
2	<i>I2 - Add-on module</i> Applied	A new module has been applied to the system	Active	Active
3	<i>I3 - Add-on module</i> Install	An add-on module is defect or has been removed. This can be an internal add-on module	Active	Active
4	<i>I4 - Param. corrected</i> OK	A less vital parameter in the transmitter has been replaced by its default value	Active	Active
20	<i>W20 - Totalizer 1</i> Reset manually	During initialisation the check of the saved totalizer value has failed. It is not possible to rely on the saved totalizer value anymore. The totalizer value must be reset manually in order to rely on future readings	Active	Active
20	<i>W20 - Totalizer 2</i> Reset manually	During initialisation the check of the saved totalizer value has failed. It is not possible to rely on the saved totalizer value anymore. The totalizer value must be reset manually in order to rely on future readings	Active	Active
21	<i>W21 - Pulse overflow</i> Adj. pulse settings	Actual flow is too big compared with pulse width and volume/pulse	Reduced pulse width	Active
22	<i>W22 - Batch timeout</i> Check installation	Duration of batching has exceeded a predefined maximum time	Batch output on zero	Active
23	<i>W23 - Batch overrun</i> Check installation	Batch volume has exceeded a predefined maximum overrun volume	Batch output on zero	Active
24	<i>W24 - Batch neg. flow</i> Check flow direction	Negative flow direction during batch	Active	Active
30	<i>W30 - Overflow</i> Adj. $Q_{max}$	Flow is above $Q_{max}$ settings	Max. 120 %	Active
31	<i>W31 - Empty pipe</i>	Pipe is empty	Zero	Active
40	<i>P40 - SENSORPROM®</i> Insert/change	SENSORPROM® unit not installed	Active	Active
41	<i>P41 - Parameter range</i> Switch off and on	A parameter is out of range. The parameter could not be replaced by its default value. The error will disappear at the next power-on	Active	Active

8.2 List of error numbers

<b>Error No.</b>	<b>Error text Remedy text</b>	<b>Comment</b>	<b>Output status</b>	<b>Input status</b>
42	<i>P42 - Current output</i> Check cables	Current loop is disconnected or the loop resistance is too big	Active	Active
43	<i>P43 - Internal error</i> Switch off and on	Too many errors occurred at the same time. Some errors are not detected correctly	Active	Active
44	<i>P44 - CT SENSORPROM®</i>	SENSORPROM® unit has been used as CT version	Active	Active
60	<i>F60 - CAN comm. error</i> Transmitter/AOM	CAN bus communication error. An add-on module, the display module or the transmitter is defective	Zero	Inactive
61	<i>F60 - SENSORPROM® error</i> Replace	It is not possible to rely on the data in SENSORPROM® unit anymore	Active	Active
62	<i>F62 - SENSORPROM® ID</i> Replace	The SENSORPROM® unit ID does not comply with the product ID. The SENSORPROM® unit is from another type of product SITRANS F C, SITRANS F US etc.	Zero	Inactive
63	<i>F63 - SENSORPROM®</i> Replace	It is not possible to read from the SENSORPROM® unit anymore	Active	Active
70	<i>F70 - Coil current</i> Check cables	Coil excitation has failed	Active	Active
71	<i>F71 - Internal error</i> Replace transmitter	Internal conversion error in ASIC	Active	Active

## Service and maintenance

The device is maintenance-free, however, a periodic inspection according pertinent directives and regulations must be carried out.

An inspection can include check of:

- Ambient conditions
- Seal integrity of the process connections, cable entries, and cover screws
- Reliability of power supply, lightning protection, and grounds

Under ideal conditions the flowmeter will operate continuously with no manual adjustment or intervention required.

The SITRANS F M Vericator is an external tool developed for verifying the MAG 5000/6000 system, installation, and application. It is a highly advanced instrument, which carries out the complex verification of the entire flowmeter system according to unique SIEMENS patented principles. The verification test is automated and the instrument easy to use, so no human error or influence will affect the verification.

### 9.1 Transmitter check list

If unstable/wrong measurements occur, it is often due to insufficient/wrong earthing or potential equalization. If earthing connection is OK, check transmitter as described below, and sensor as described in sensor check lists (see the respective operating instructions).

The easiest way to check the transmitter in a SITRANS F M installation is to replace the transmitter with another MAG 5000/6000 with a similar power supply.

As all settings are stored in and downloaded from the SENSORPROM®, replacement is easily done and no extra settings need to be made.

#### Check transmitter

If no replacement transmitter is available, check transmitter according to the following check table.

Power on transmitter		
0	Display light on?	Yes ⇒ 1
		No ⇒ 2
1	Flashing error triangles?	Yes ⇒ Check error table
		No ⇒ 1.2
1.2	Output and display readings OK?	Yes ⇒ 1.2.1
		No ⇒ 1.2.2

Power on transmitter		
1.2.1	Transmitter OK	Check application Check installation/sensor/earthing connection etc.
1.2.2	Check cables/conndections Check connection board Check pins in transmitter multiplug	OK ⇒ 1.2.1
		Not OK ⇒ correct fault
2	Check cables/conndections Check connection board Check pins in transmitter multiplug	OK ⇒ 2.1
		Not OK ⇒ Correct fault
2.1	Output readings OK?	Yes ⇒ 2.1.1
		No ⇒ 2.1.2.
2.1.1	Dispaly defective	Replace display
2.1.2	Transmitter defective	Replace transmitter

**Note**

**Sensor check list**

Check list for sensors are included in the respective sensor operating instructions.

## 9.2 Technical support

<b>NOTICE</b>
Repair and service must be carried out by approved Siemens Flow Instruments personnel only.

**Note**

Siemens Flow Instrument defines sensors as non-repairable products.

### Technical Support

If you have any technical questions about the device described in these Operating Instructions and do not find the right answers, you can contact Technical Support:

- Via the Internet using the **Support Request:**  
Support request (<http://www.siemens.com/automation/support-request>)
- Phone: +49 (0) 180 5050 222

Further information about our technical support is available in the Internet at Technical support (<http://support.automation.siemens.com/WW/view/en/16604318>)

## Service & Support on the Internet

In addition to our documentation, we offer a comprehensive knowledge base online on the Internet at:

Service and support (<http://www.siemens.com/automation/service&support>)

There you will find:

- The latest product information, FAQs, downloads, tips and tricks.
- Our newsletter, providing you with the latest information about your products.
- A Knowledge Manager to find the right documents for you.
- Our bulletin board, where users and specialists share their knowledge worldwide.
- You can find your local contact partner for Industry Automation and Drives Technologies in our partner database.
- Information about field service, repairs, spare parts and lots more under "Services."

## Additional Support

Please contact your local Siemens representative and offices if you have additional questions about the device

Find your contact partner at:

Local contact person (<http://www.automation.siemens.com/partner>)

## 9.3 Return procedures

Enclose the delivery note, the cover note for return delivery together with the declaration of decontamination form on the outside of the package in a well-fastened clear document pouch.

### Required forms

- **Delivery Note**
- **Cover Note for Return Delivery** with the following information

Cover note

([http://cache.automation.siemens.com/dnl/zY/zY0OTg1AAAA\\_16604370\\_TxtObj/Begleitschein\\_RW\\_AD.pdf](http://cache.automation.siemens.com/dnl/zY/zY0OTg1AAAA_16604370_TxtObj/Begleitschein_RW_AD.pdf))

- product (ordering number)
- number of devices or spare parts returned
- reason for the return

- **Declaration of Decontamination**

Decontamination declaration

([http://pia.khe.siemens.com/efiles/feldg/files/Service/declaration\\_of\\_decontamination\\_en.pdf](http://pia.khe.siemens.com/efiles/feldg/files/Service/declaration_of_decontamination_en.pdf))

With this declaration you certify *that the returned products/spare parts have been carefully cleaned and are free from any residues.*

If the device has been operated together with toxic, caustic, flammable or water-damaging products, clean the device before return by rinsing or neutralizing. Ensure that all cavities are free from dangerous substances. Then, double-check the device to ensure the cleaning is completed.

We will not service a device or spare part unless the declaration of decontamination confirms proper decontamination of the device or spare part. Shipments without a declaration of decontamination will be cleaned professionally at your expense before further proceeding.

You can find the forms on the Internet and on the CD delivered with the device.

## 9.4 Recalibration

Siemens A/S Flow Instruments offers to recalibrate the sensor. The following calibrations are offered as standard:

- Standard matched pair calibration

---

### Note

For recalibration the SENSORPROM® memory unit must always be returned with the sensor.

---

## Troubleshooting/FAQs

Symptom	Output signals	Error code	Cause	Remedy
Empty display	Minimum		1. No power supply	Power supply Check MAG 5000/6000 for bended pins on the connector
			2. MAG 5000/6000 defective	Replace MAG 5000/6000
No flow signal	Minimum		1. Current output disabled	Turn on current output
			2. Digital output disabled	Turn on digital output
			3. Reverse flow direction	Change direction
	Undefined	F70	Incorrect or no coil current	Check cables/connections
		W31	Measuring pipe empty	Ensure that the measuring pipe is full
		F60	Internal error	Replace MAG 5000/6000
		P42	1. No load on current output	Check cables/connections
2. MAG 5000/6000 defective	Replace MAG 5000/6000			
P41	Initializing error	Switch off MAG 5000/6000, wait 5 sec. and switch on again		
Indicates flow with no flow in pipe	Undefined		Measuring pipe empty	Select empty pipe cut-off
			Empty pipe cut-off is OFF	Ensure that the measuring pipe is full
			Electrode connection missing/electrode cable is insufficiently screened	Ensure that electrode cable is connected and sufficiently screened
Unstable flow signal	Unstable		1. Pulsating flow	Increase time constant
			2. Conductivity of medium too low	Use special electrode cable
			3. Electrical noise potential between medium and sensor	Ensure sufficient potential equalization
			4. Air bubbles in medium	Ensure medium does not contain air bubbles
			5. High concentration of particles or fibres	Increase time constant
Measuring error	Undefined		Incorrect installation	Check installation
		P40	No SENSORPROM® unit	Install SENSORPROM® unit
		P44	CT SENSORPROM® unit	Replace SENSORPROM® unit or reset SENSORPROM® unit with MAG CT transmitter
		F61	Defective SENSORPROM® unit	Replace SENSORPROM® unit
		F62	Wrong type of SENSORPROM® unit	Replace SENSORPROM® unit

Symptom	Output signals	Error code	Cause	Remedy
		F63	Defective SENSORPROM® unit	Replace SENSORPROM® unit
		F71	Loss of internal data	Replace MAG 5000/6000
	Maximum	W30	Flow exceeds 100% of Qmax.	Check Q <sub>max</sub> (Basic Settings)
		W21	Pulse overflow Volume/pulse too small	Change volume/pulse
			Pulse width too large	Change pulse width
Measuring approx. 50%			Missing one electrode connection	Check cables
Loss of totalizer data	OK	W20	Initializing error	Reset totalizer manually
##### Signs in display	OK		Totalizer roll over	Reset totalizer or increase totalizer unit



## Technical data

### 11.1 Technical specifications



<b>Mode of operation and design</b>	Measuring principle	Electromagnetic with pulsed constant field
	Empty pipe	Detection of empty pipe (special cable required in remote mounted installation)
	Excitation frequency	Depends on sensor size
	Electrode input impedance	$> 1 \times 10^{14} \Omega$
<b>Input</b>	<b>Digital input</b>	11 ... 30 V DC, $R_i = 4.4 \text{ k}\Omega$
	Activation time	50 ms
	Current	$I_{DC 11 \text{ V}} = 2.5 \text{ mA}$ , $I_{DC 30 \text{ V}} = 7 \text{ mA}$
<b>Output</b>	<b>Current output</b>	
	Signal range	0 ... 20 mA or 4 ... 20 mA, Alarm
	Load	$< 800 \Omega$
	Time constant	0.1 ... 30 s, adjustable (for batch: fixed at 0.1 s)
	<b>Digital output</b>	
	Frequency	0 ... 10 kHz, 50% duty cycle (uni/bidirectional)
	Pulse (active)	DC 24 V, 30 mA, $1 \text{ k}\Omega \leq R_i \leq 10 \text{ k}\Omega$ , short-circuit protected (power supplied from flowmeter)
	Pulse (passive)	DC 3 ... 30 V, max. 110 mA, $200 \Omega \leq R_i \leq 10 \text{ k}\Omega$ (powered from connected equipment)
	Time constant	0.1 ... 30 s, adjustable (for batch: fixed at 0.1 s)
	<b>Relay output</b>	
Time constant	Changeover relay, same as current output	
Load	42 V AC/2 A, 24 V DC/1 A	
<b>Low flow cut off</b>	0 ... 9.9% of maximum flow	
<b>Galvanic isolation</b>	All inputs and outputs are galvanically isolated	
<b>Max. measuring error (incl. sensor and zero point)</b>	MAG 5000	$0.4\% \pm 1 \text{ mm/s}$ (for $v > 0.1 \text{ m/s}$ )

Technical data

11.1 Technical specifications

	MAG 6000	0.2% ± 1 mm/s (for v > 0.1 m/s)
<b>Functions</b>	Flow rate, 2 totalizers, low-flow cut-off, empty pipe cut-off, flow direction, error system, operating time, uni/bidirectional flow, limit switches, pulse output, control for cleaning and batch	
<b>Rated operation conditions</b>	<b>Ambient temperature</b>	
	Operation	Standard IP67, 19", blind and SV versions: -20 ... +60 °C (-4 ... +140 °F) CT version: -20 ... +50 °C (-4 ... +122 °F)
	Storage	-40 ... +70 °C (-40 ... +158 °F)
<b>Mechanical load</b>	18 ... 1000 Hz, 3.17 G rms, sinusoidal in all directions to IEC 68-2-36	
<b>Degree of protection</b>	IP67/NEMA 4X/6 to IEC 529 and DIN 40050 (1 mH <sub>2</sub> O 30 min.)	
<b>EMC performance</b>	EN 61326-1 (industrial environments)	
	EN 61326-2-5	
<b>Display and keypad</b>	Totalizer	Two eight-digit counters for forward, net or reverse flow
	Display	Background illumination with alphanumeric text, 3 x 20 characters to indicate flow rate, totalized values, settings and faults; Reverse flow indicated by negative sign
	Time constant	Time constant as current output time constant
<b>Design</b>	Enclosure material	Fiber glass reinforced polyamide; optional (IP67 only): AISI 316 stainless steel
	Dimensions	See dimensional drawings
	Weight	0.75 kg (2 lb)
<b>Power supply</b>	115 ... 230 V AC +10% -15%, 50 ... 60 Hz, Fuse: 500 mA T 11 ... 30 V DC or 11 ... 24 V AC; Fuse 2 A T	
<b>Power consumption</b>	115 ... 230 V AC: 17 VA 24 V AC: 9 VA, I <sub>N</sub> = 380 mA, I <sub>ST</sub> = 8 A (30 ms) 12 V DC: 11 W, I <sub>N</sub> = 920 mA, I <sub>ST</sub> = 4 A (250 ms)	
<b>Certificates and approvals</b>	CE, C-UL US general purpose, C-tick, CSA/FM Class 1, div 2	
	Custody transfer approval (MAG 5000/6000 CT)	Cold water pattern approval: PTB OIML R 49, MI-001 Hot water pattern approval: DANAK OIML R 75 (MAG 6000 CT) Other media than water (milk, beer etc.) pattern approval: DANAK OIML R 117 (MAG 6000 CT) Energy metering : PTB K7.2
<b>Communication</b>	MAG 5000	Without communication or HART as option
	MAG 6000	Prepared for client mounted add-on modules: HART, MODBUS RTU/RS485, FOUNDATION Fieldbus H1, DeviceNet, PROFIBUS PA, PROFIBUS DP as add-on modules
	MAG 5000 CT / MAG 6000 CT	No communication modules approved

Transmitter IP67/NEMA 4X/6 compact polyamide

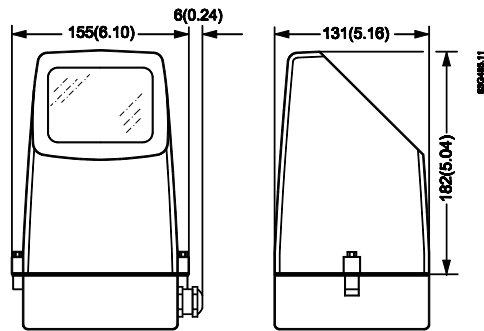

Weight: MAG 5000/6000: 0.75 kg (1.65 lbs)

Transmitter IP67/NEMA 4X/6 wall-mounted polyamide

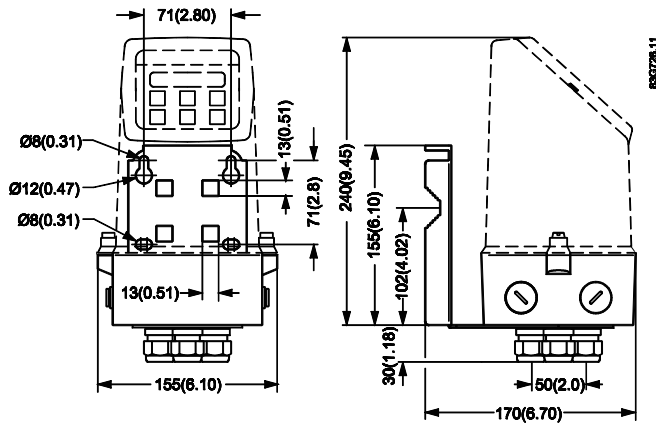

Weight(transmitter and wall mounting bracket): 1.65 kg (3.64 lbs)

## 11.2 Accuracy

For accuracy reference conditions, please see below.

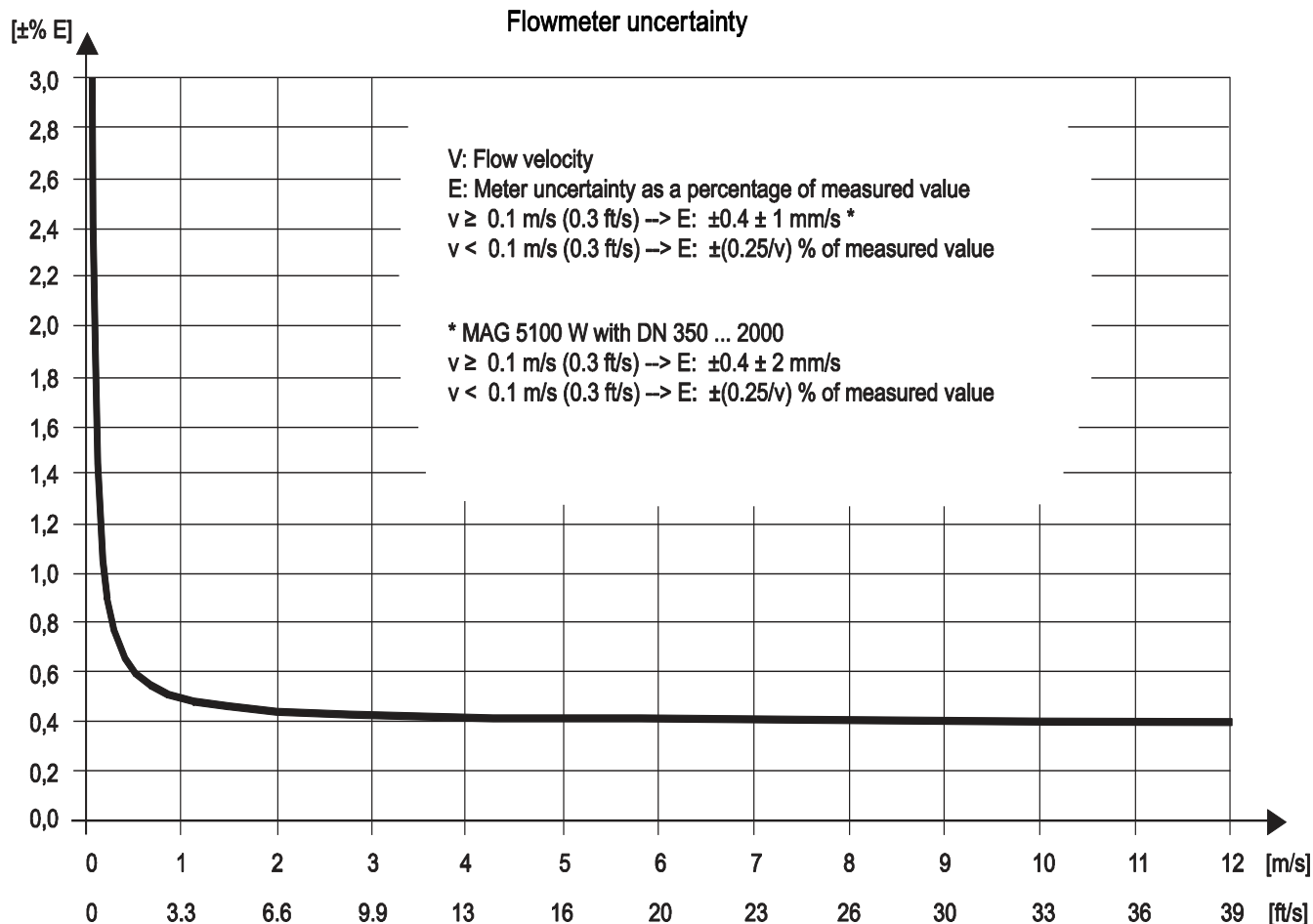

Figure 11-1 MAG 5000 with MAG 1100, MAG 1100 F, MAG 5100 W, MAG 3100 and MAG 3100 P and MAG 6000 with MAG 1100 (PFA), MAG 1100 F (PFA)

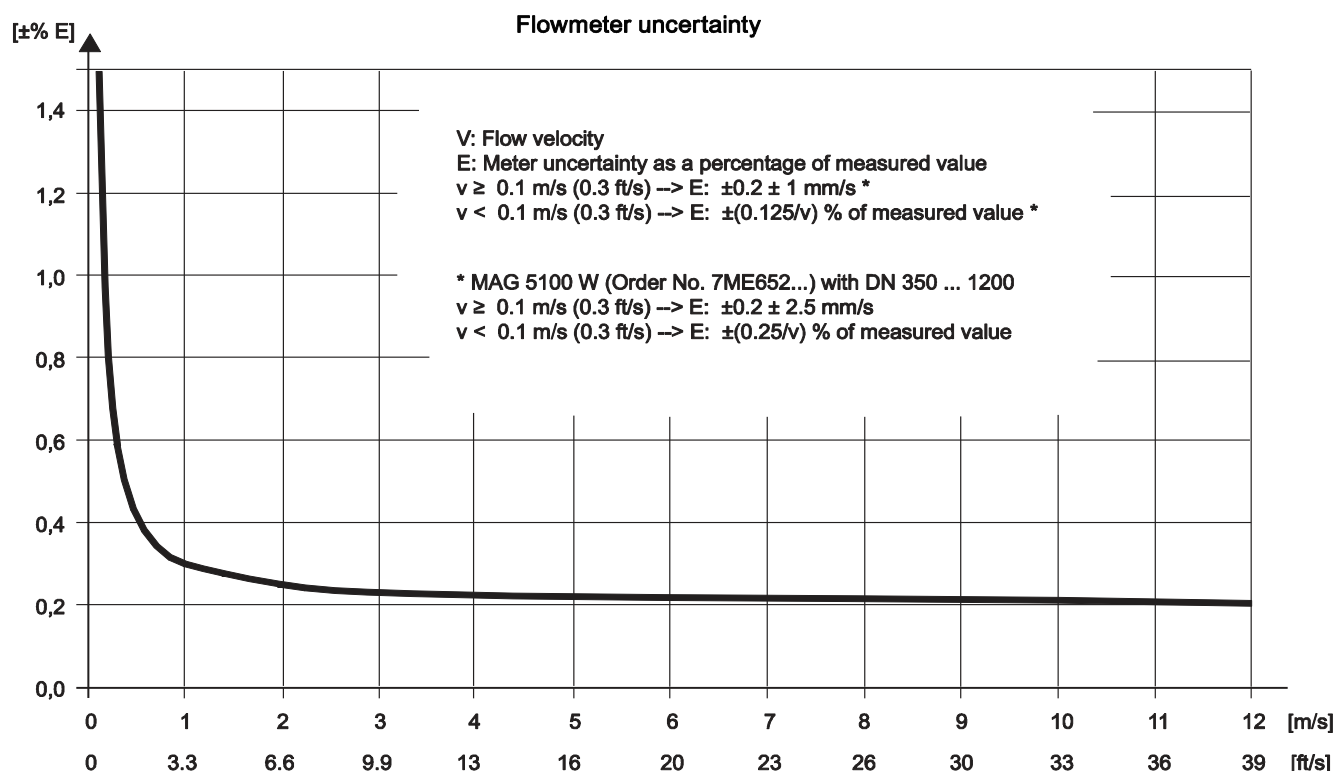

Figure 11-2 MAG 6000 with MAG 1100 (not PFA), MAG 1100 F (not PFA), MAG 5100 W, MAG 3100 and MAG 3100 P

**Reference conditions**

(ISO 9104 and DIN/EN 29104)

A calibration certificate is shipped with every sensor and calibration data are stored in SENSORPROM memory unit.

Medium temperature	20°C ± 5°C (68°F ± 9°C)
Ambient temperature	20°C ± 5°C (68°F ± 9°C)
Supply voltage	U <sub>n</sub> ± 1%
Warming-up time	30 minutes
Incorporation in conductive pipe section	
Inlet section	10 x DN (DN ≤ 1200/48") 5 x DN (DN > 1200/48")
Outlet section	5 x DN (DN ≤ 1200/48") 3 x DN (DN > 1200/48")
Flow conditions	Developed flow profile

Reference conditions for sensor calibration

11.3 Output characteristics

Current output	As pulse output $\pm$ (0.1% of actual flow + 0.05% FSO)
Effect of ambient temperature Display/frequency/pulse output Current output	$< \pm 0.003\%$ / °C act. $< \pm 0.005\%$ / °C act.
Effect of supply voltage	$< 0.005\%$ of measuring value on 1% change
Repeatability	$\pm 0.1\%$ of actual flow for $V \geq 0.5$ m/s (1.5 ft/s) and conductivity $\geq 10$ $\mu$ S/cm

Additions in the event of deviations from reference conditions

## 11.3 Output characteristics

### Current output

Output characteristics	Bidirectional mode	Unidirectional mode
0...20 mA		
4...20 mA		

### Frequency output

Bidirectional mode	Unidirectional mode

Pulse output

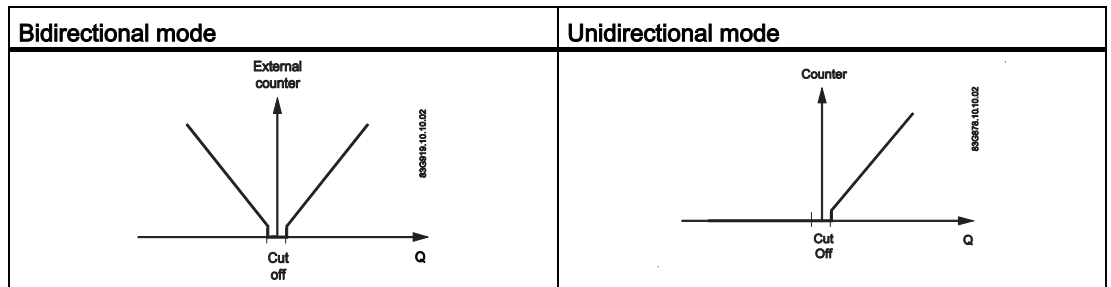

Relay output

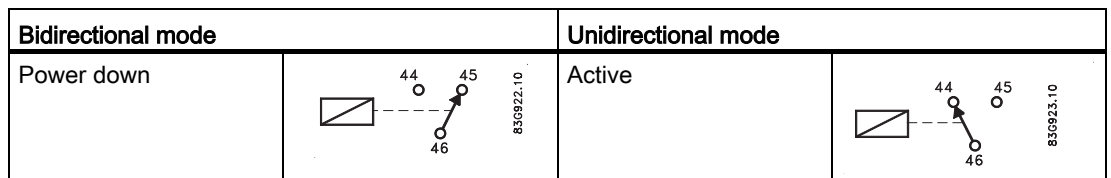

Error relay output

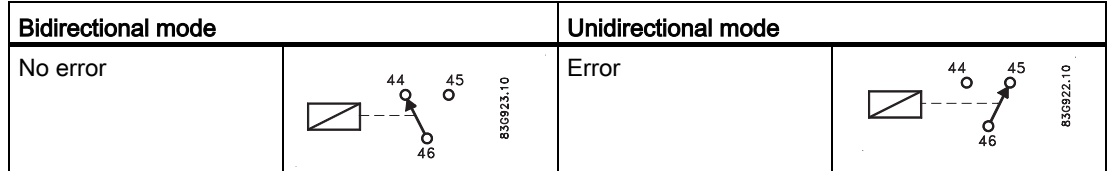

Limit switch (can be used as direction switch)

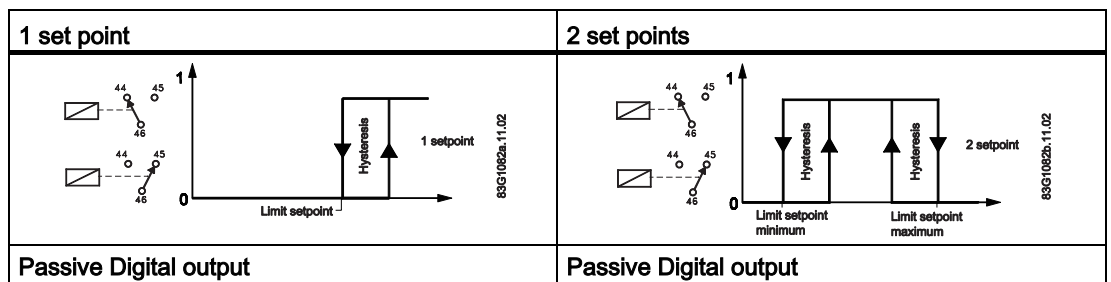

11.3 Output characteristics

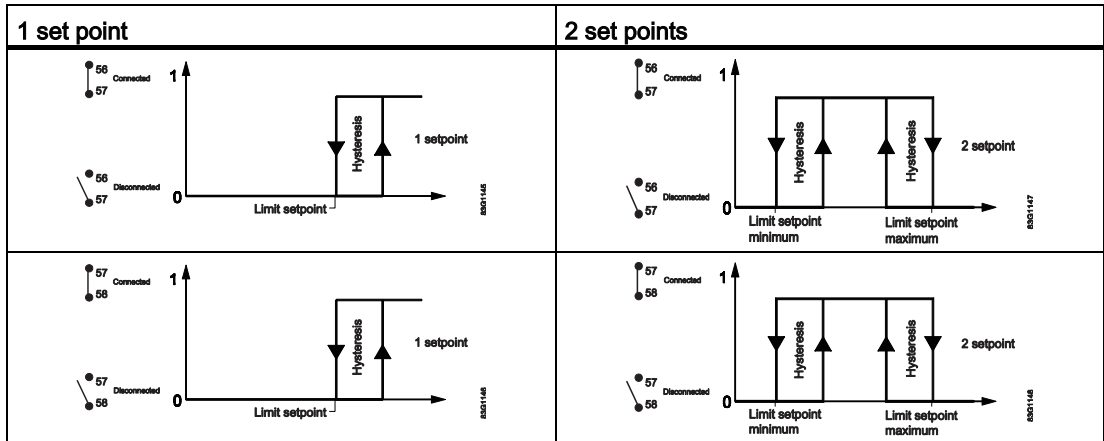

Note

Active digital output is not available with MAG 6000 I.

Batch on digital output

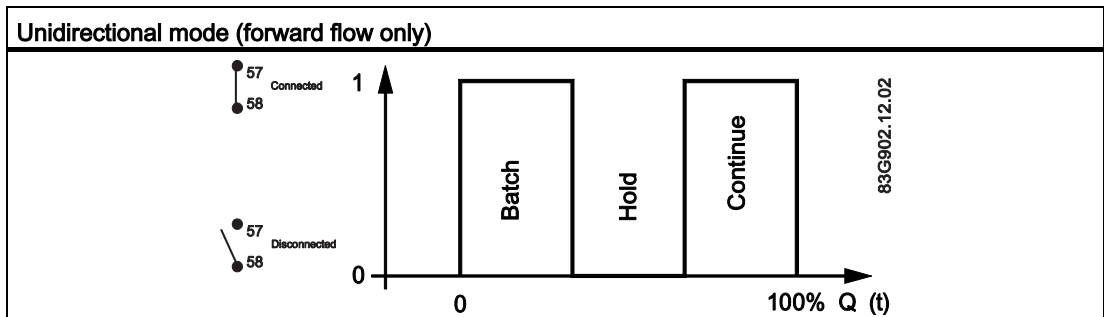

Totalizer lap

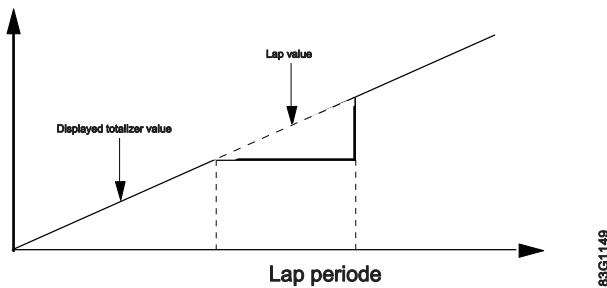



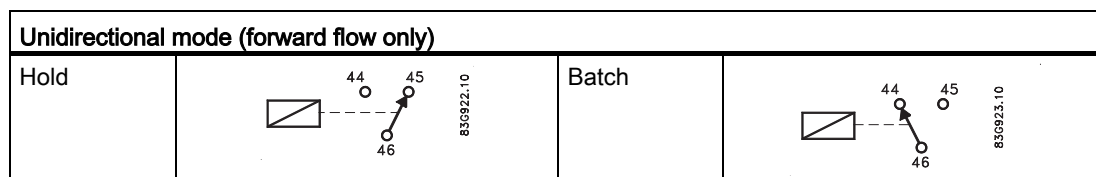

### Batch on relay output



## 11.4 Cable data

### Description

Cable for standard electrode or coil	
Electrode cable, double shielded	
Cable kit with standard coil cable and electrode cable double shielded (also available as low noise cable for MAG 1100 sensor )	

### Technical data

		Standard electrode cable (electrode/coil)	Special cable (electrode)
Basic data	No. of conductors	3	3
	Sqr. area	1.5 mm <sup>2</sup>	0.25 mm <sup>2</sup>
	Screen	Yes	Double
	Color code	Brown, blue, black	Brown, blue, black
	Outside color	Grey	Grey
	Ext. diameter	7.8 mm	8.1 mm
	Conductor	Flexible CU	Flexible CU
	Isolation material	PVC	PVC
Ambient temperature	Flexible installation	-5 ... +70°C (23 ... 158°F)	-5 ... +70°C (23 ... 158°F)
	Non-flexible installation	-30 ... +70°C (-22 ... 158°F)	-30 ... +70°C (-22 ... 158°F)
Cable parameter	Capacity	161.50 pF/m	N/A
	Inductance	0.583 μH/m	N/A
	L/R	43.83 pH/Ω	N/A

## 11.5 Cable requirements

		Coil cable	Electrode cable
<b>Basic data</b>	No. of conductors	2	3
	Min. sqr. area	0.5 mm <sup>2</sup>	0.2 mm <sup>2</sup>
	Screen	Yes	Yes
	Max. capacitance	N/A	350 pF/m
<b>Max. cable loop resistance</b>	Media temperature:		
	< 100 °C	40 Ω	N/A
	> 200 °C	6 Ω	N/A
<b>Cable glands on sensor</b>	M20x1.5 gland - Cable ø 5 ... 13 mm (0.20 ... 0.51 inches)		
	½ NPT gland - cable ø 5 ... 9 mm (0.20 ... 0.35 inches)		

 **WARNING**

**Cable glands**

For Ex zone 1 installations only certified cable glands with protection type "e" can be used for the power supply and the coil cable. The cable glands must be approved for the actual temperature and cable dimension.



## Spare parts/Accessories

### 12.1 Ordering



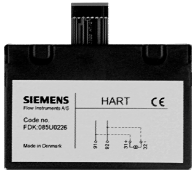

In order to ensure that the ordering data you are using is not outdated, the latest ordering data is always available on the Internet:

Catalog process instrumentation (<http://www.siemens.com/processinstrumentation/catalogs>)

### 12.2 Accessories

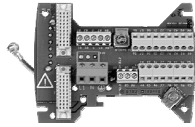
Description	
Wall mounting unit	
Display protection lid	
Communication modules for MAG 6000	

## 12.3 Spare parts

Description	
Connection plate	
SENSORPROM® memory unit	
Display unit	
Communication modules for MAG 6000	

## 12.4 Sun shield

Description	
Sun shield	

## Menu diagrams

### A.1 Transmitter menu overview

The menu diagrams shown on the following pages apply to MAG 5000/6000 as well as MAG 6000 I.

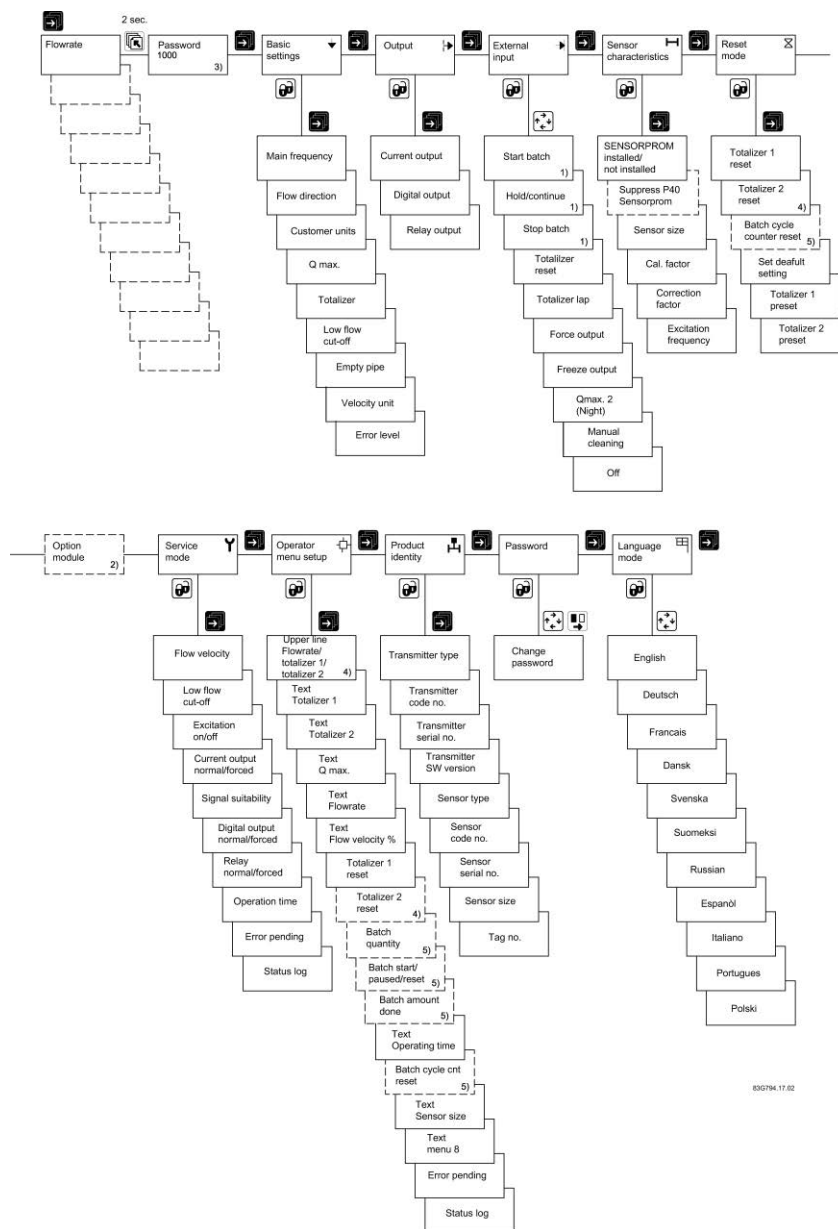

- 1) Not available in MAG 5000
- 2) Add-on module
- 3) Factory-set password: 1000
- 4) Not available when batch
- 5) Only available when batch

## A.2 Basic settings

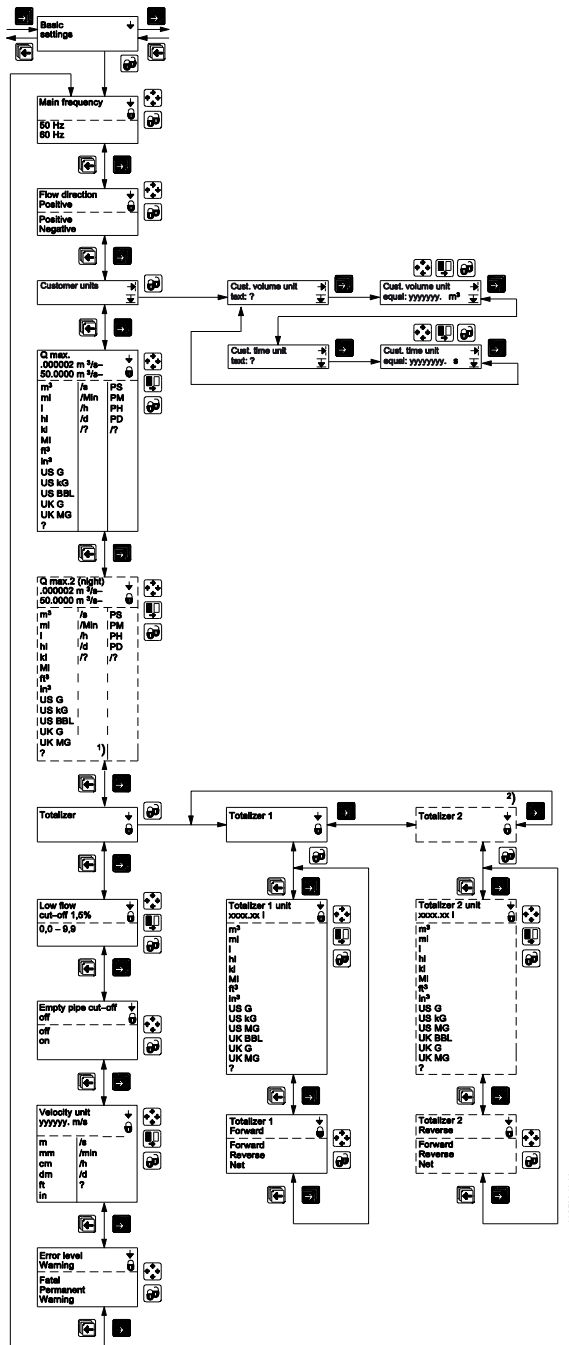

- 1) The question mark at unit selections stand for customer units. The unit is shown as a question mark on display if not overwritten with customer's own unit text setup using PDM or ordered specially using Y20 in ordering system.  
The flow rate unit can be "?/?" or show customer unit texts as for example "AcrFt/y" (Acre feet/year).
- 2) When batch is selected on digital output or relay, Totalizer 2 is not shown because it is controlled by the batch function.

## A.3 Current output

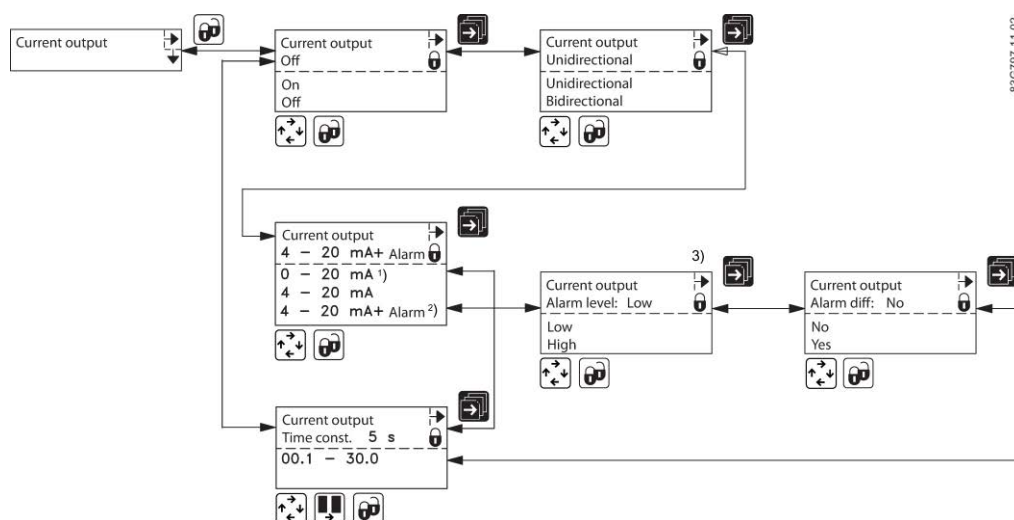

- 1) If HART communication is installed, it is not possible to set the output for 0-20 mA (even though the option is visible in the display). This is due to the fact that HART does not work if the output falls below 2-3 mA.
- 2) 4-20 mA + Alarm is the default setting for MAG 6000 I. For all other variants, the default setting is 4-20 mA.
- 3) The controlling of alarm levels does not recognize if the jumper is mounted for passive output. Do not combine differentiation and low alarm level together with passive output. The output will try to pull down the level to 1.3 mA at fatal errors which is not possible for passive output.

### A.4 Digital output - pulse

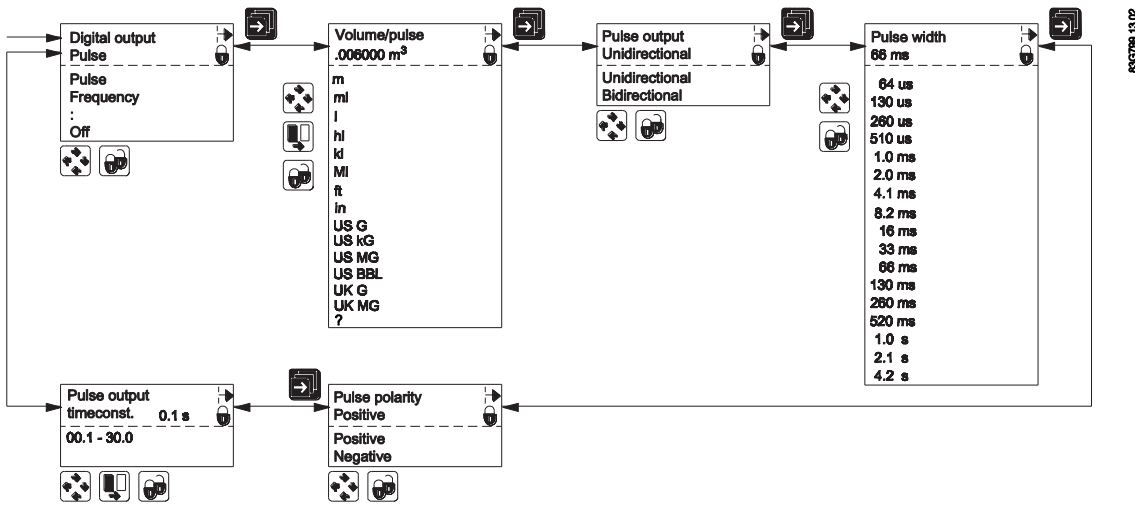

### A.5 Digital output - frequency

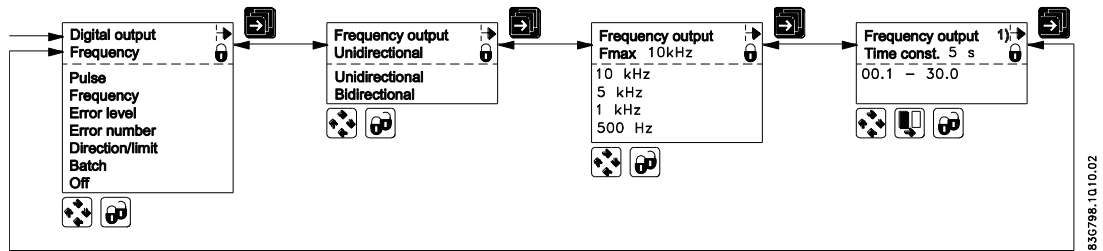

### A.6 Error level

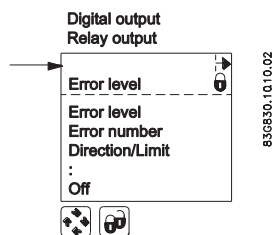



## A.7 Error number

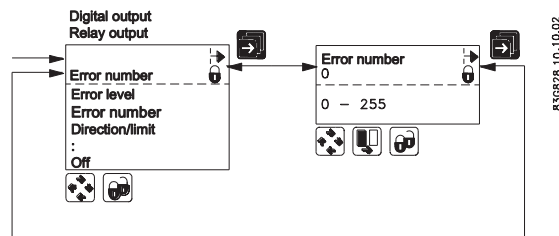

## A.8 Direction/limit

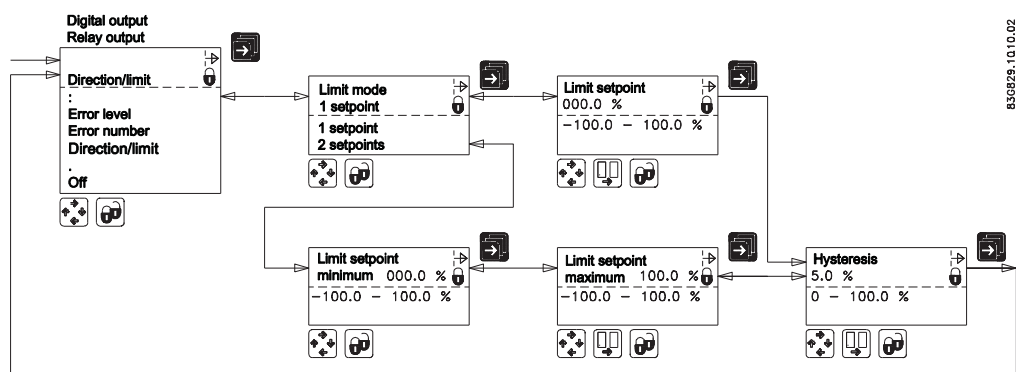

## A.9 Batch

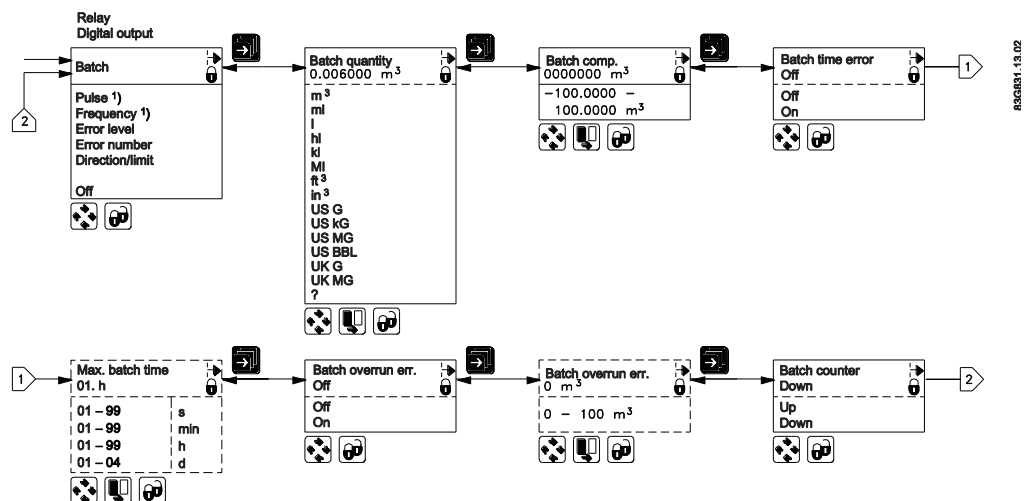

1) Visible only on Digital output.

### Note

If batch function is chosen on the relay output, the digital output will be turned off if it has been set up for pulse, frequency or batch.

If digital output is set up for pulse, frequency or batch, then the relay output will be turned off if it has been set up for batch.

## A.10 External input

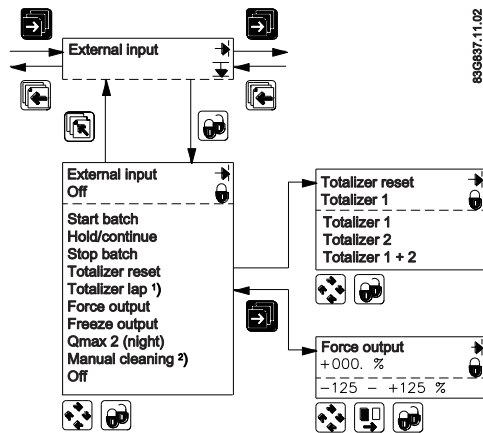

- 1) The value showing totalizer 1 on the display is frozen for as long as the digital output is activated. However, totalizer 1 continues counting, and when the digital input is released, the value on the display again follows totalizer 1.
- 2) MAG 6000 I cannot be equipped with cleaning unit. The cleaning option for relay output is however possible. When selecting function for MAG 6000 I relay output, the relay output has the same behavior as if cleaning unit was installed.

The relay output of the transmitter determines when the relay is on by applying voltage for approximately 60 seconds. The metering is resumed after another 60 seconds when the cycle is complete. (The display is locked during this time). The time cycle can be set at 1 to 240 hours. If the cycle is set at for example three hours, the transmitter will be active every three hours.

## A.11 Sensor characteristics

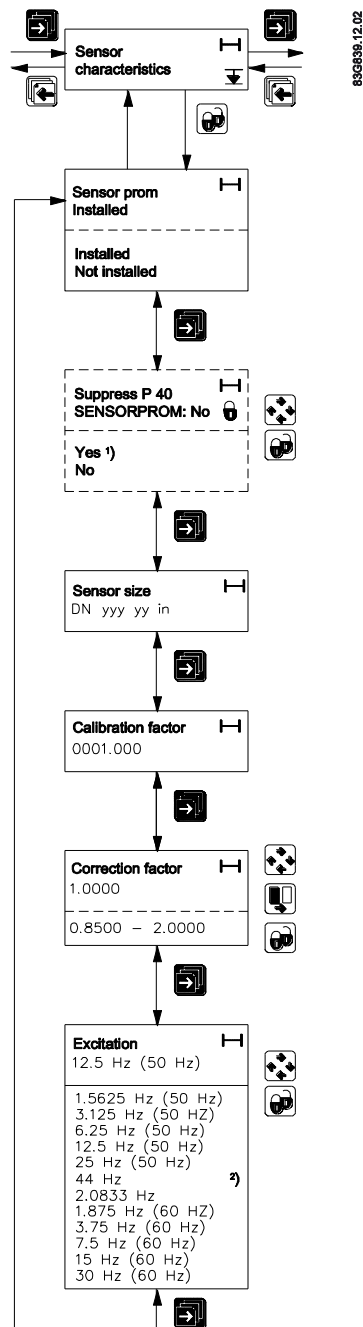

- 1) Error status (level or number) on an output is updated only at the time the error status changes (occurs or disappears). If P40 is suppressed after it has been detected (at power up), the output does not change state. In this case the power must be switched off/on to suppress the P40 error on the output.
- 2) The frequency can be set to 44 Hz in the MAG 6000 SV transmitter only.

## A.12 Reset mode

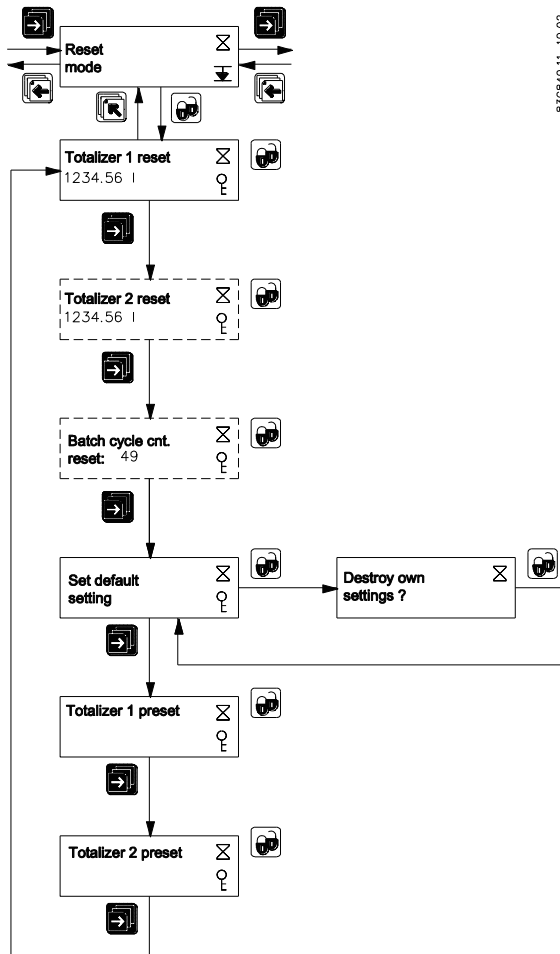

830840.11 -10.02

### A.13 Reset mode - MAG 6000 SV

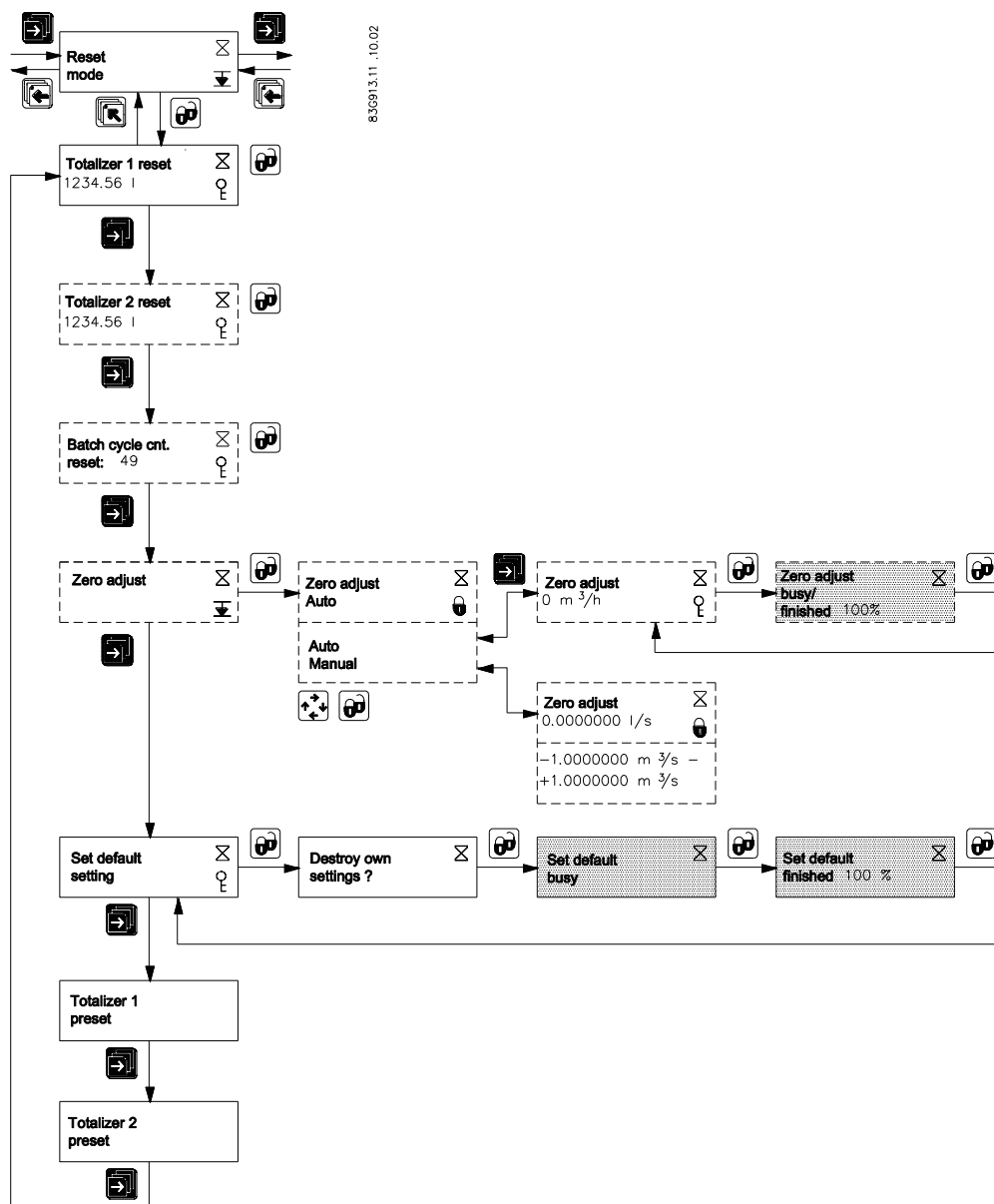

## A.14 Service mode

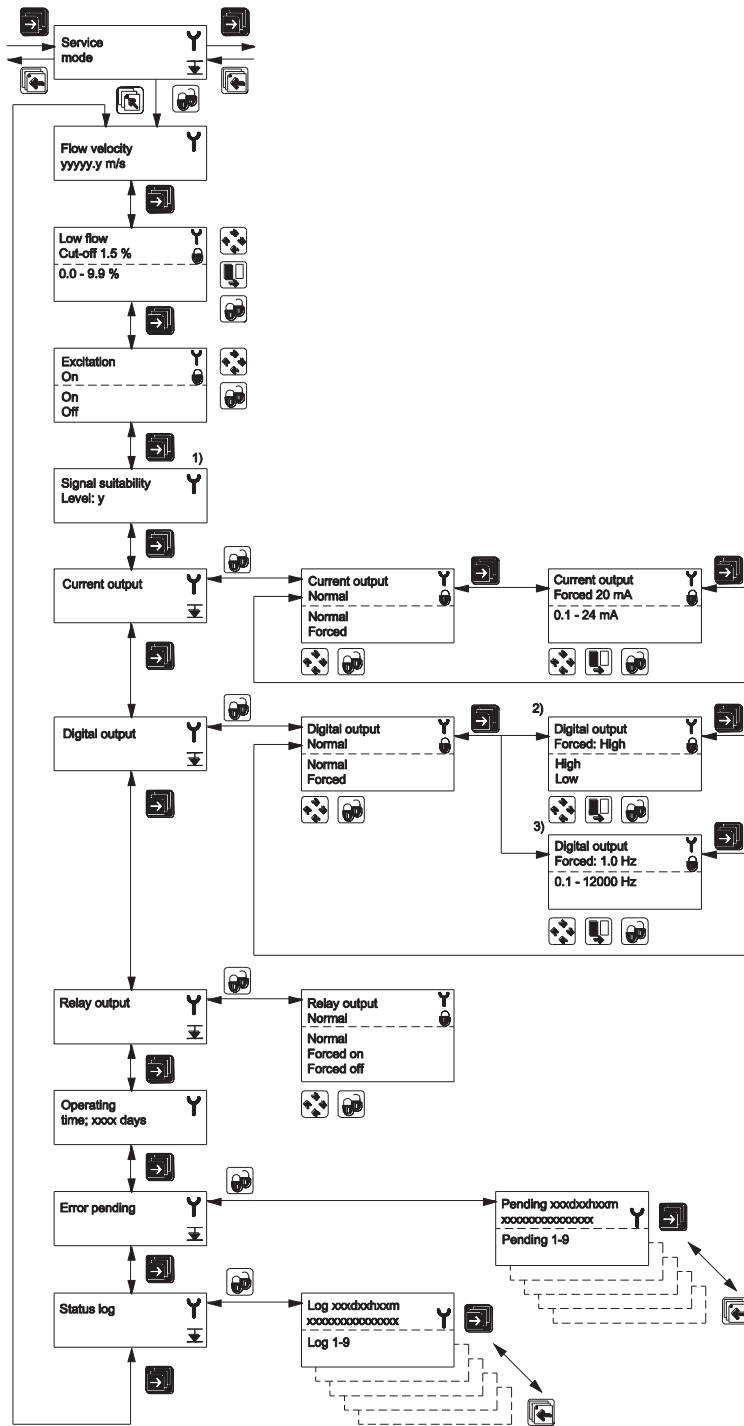

RS0838-12.02

- 1) Signal suitability is a level from 0 to 9 of the electrode measured voltage. Level 0 is equal to the limit value that is set for empty pipe error detection, and level 9 is the best signal measured.
- 2) If digital output is set to pulse (standard).
- 3) If digital output is set to frequency.

# A.15 Operator menu setup

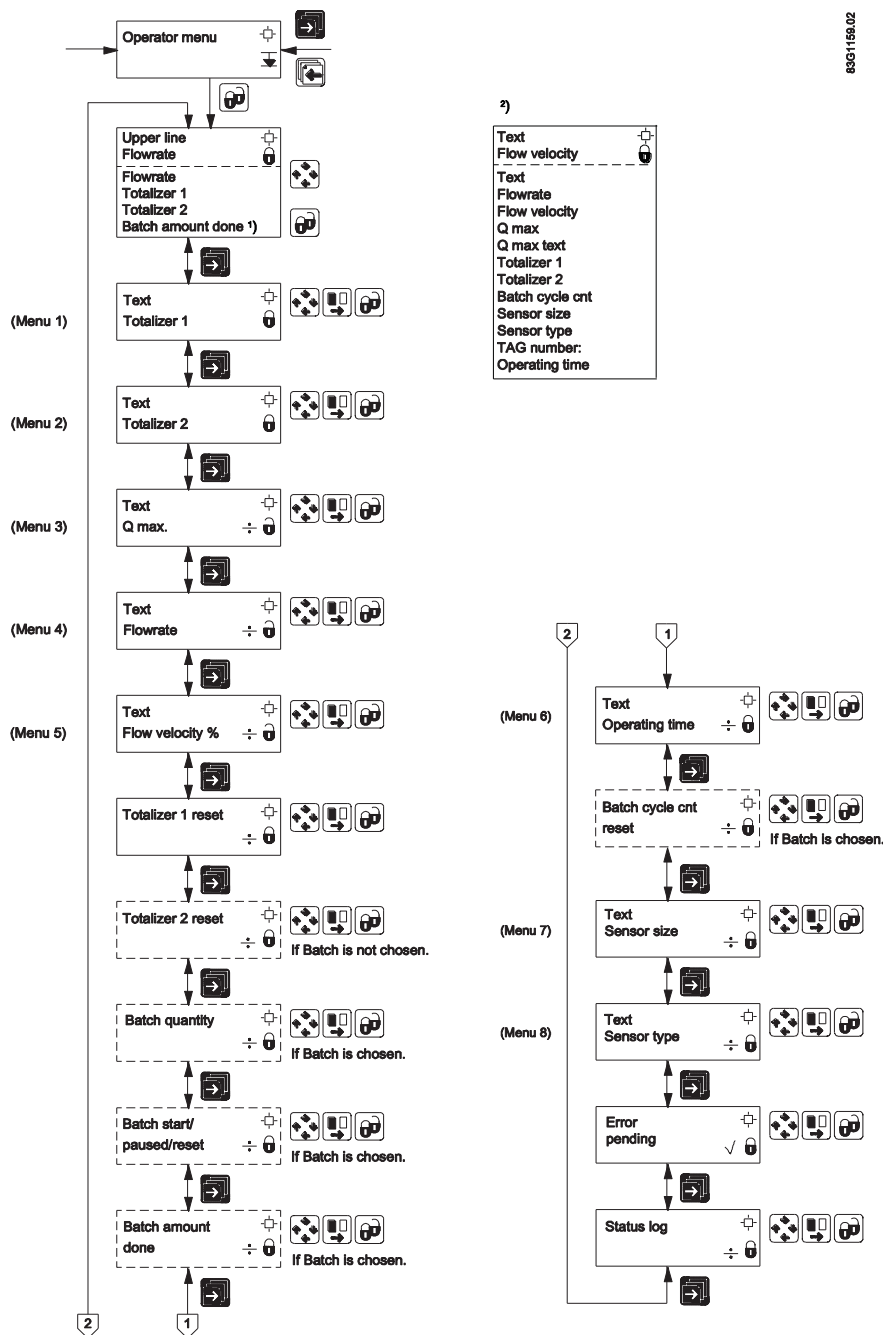

- 1) When selecting Batch amount for upper line, the upper line is initially blank. The amount done may not appear until the batch is started.
- 2) 'Text' means that the text for the chosen measured value is shown. For example, if text is chosen in line 2 and flow velocity is chosen in line 3, the text "Flow velocity " is shown in line 2 and the measured flow velocity is shown in line 3.

# A.16 Product identity

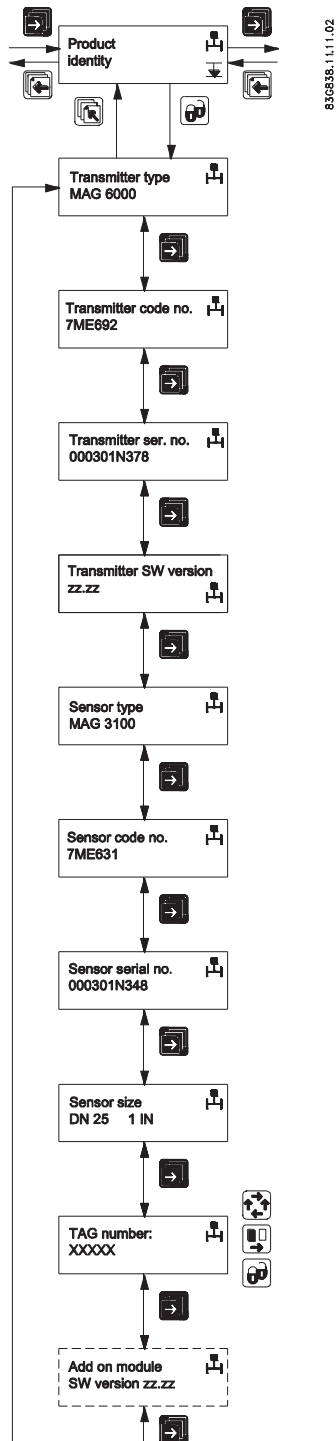



## A.17 Add-on communication module

Example: HART

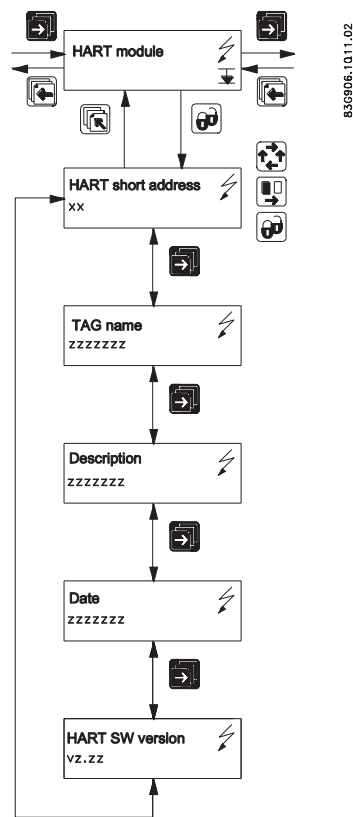

### Note

Burst mode is not available with HART communication

## A.18 Cleaning

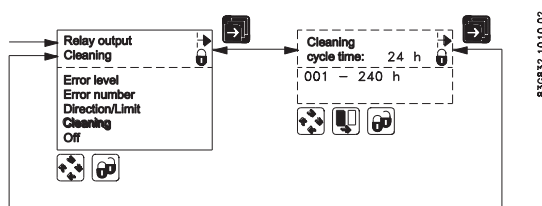

### Note

#### Relay outputs

If cleaning unit is installed, relay outputs must always be used to operate cleaning.

Relay outputs cannot be used for other purposes

## A.19 MAG 5000/6000 CT menu overview

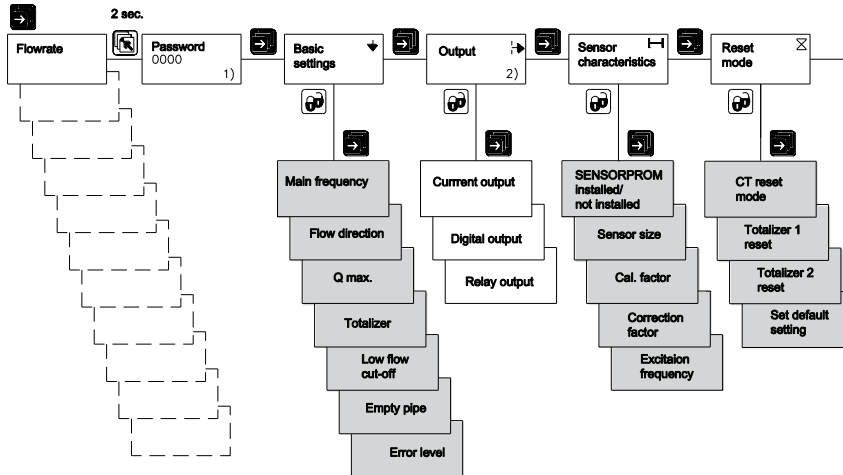
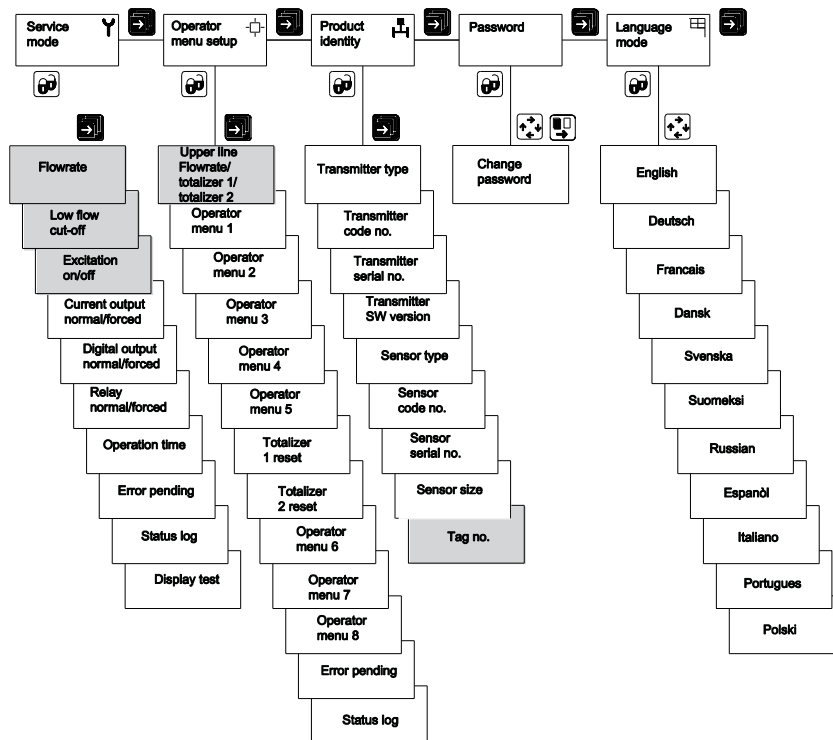

Figure A-1 Overview MAG 5000 CT and MAG 6000 CT (part 1)



83G885.11.11.02

- 1) Factory-set password: 1000
- 2) Not visible when CT mode is "Hot water"

Figure A-2 Overview MAG 5000 CT and MAG 6000 CT (part 2)

**Note**

**Sealing**

Menus marked with gray are locked when transmitter is sealed.

## A.20 Change password

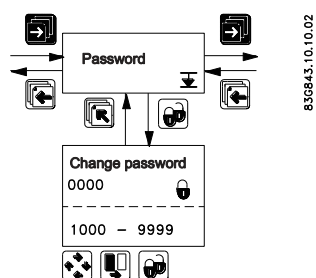



## Factory settings

### B.1 Transmitter factory settings

The factory settings shown on the following pages apply to MAG 5000/6000 as well as MAG 6000 I.

Menu item	Parameter	Factory settings	Options	More info
<b>Password</b>	Password	1000	1000 ... 9999	Changing password (Page 42) and Change password (Page 89)
<b>Basic settings</b>	Flow direction	Positive	Positive, negative	Changing basic settings (Page 43)
	Q <sub>max</sub>	Sensor size dependent	Sensor size dependent	
	• <i>volume unit</i>	<i>Sensor size dependent</i>	<i>m<sup>3</sup>, ml, l, hl, kl, Ml, ft<sup>3</sup>, in<sup>3</sup>, US G, US kG, US MG, US BBL, UK G, UK kG, UK MG, ? (customer unit)</i>	
	• <i>time unit</i>	<i>Sensor size dependent</i>	<i>Sec., min., hour, day, ? (customer unit)</i>	
	Totalizer 1	Forward	Forward, reverse, net	
	• <i>Totalizer 1 unit</i>	<i>Sensor size dependent</i>	<i>m<sup>3</sup>, ml, l, hl, kl, Ml, ft<sup>3</sup>, in<sup>3</sup>, US G, US kG, US MG, US BBL, UK G, UK kG, UK MG, ? (customer unit)</i>	
	Totalizer 2	Reverse	Forward, reverse, net	
	• <i>Totalizer 2 unit</i>	<i>Sensor size dependent</i>	<i>m<sup>3</sup>, ml, l, hl, kl, Ml, ft<sup>3</sup>, in<sup>3</sup>, US G, US kG, US MG, US BBL, UK G, UK kG, UK MG, ? (customer unit)</i>	
	Low flow cut-off	1.5%	0 ... 9.9%	
	Empty pipe	Off	On, Off	
Velocity unit	m/s	m, mm, cm, dm, ft, in per s, min, h, d, ? (customer unit)		
Error level	Warning	Fatal, permanent, warning		
<b>Output</b>	Current output	Off for MAG5000/6000 On for MAG6000I Namur	On/off, Unidirectional/bidirectional, 0...20 mA/4...20 mA/4...20 mA + Alarm	Output settings (Page 47)
	• <i>Alarm level</i>	<i>Low</i>	<i>High/Low</i>	
	• <i>Alarm diff.</i>	<i>No</i>	<i>Yes/No</i>	
	• <i>Time constant</i>	<i>5 s</i>	<i>0.1...30 s</i>	

Factory settings

B.1 Transmitter factory settings

Menu item	Parameter	Factory settings	Options	More info
	Digital output	Pulse	Error, direction/limit, batch, frequency, pulse, error number, off	Digital output - pulse (Page 78)
	Relay output	Error level	Error, direction/limit, cleaning, error number, off	Error level (Page 78)
	Direction/limit switch	Off	1 setpoint, 2 setpoints	Direction/limit (Page 79)
	• <i>Setpoints</i>	0%	-100 ... +100%	
	• <i>Hysteresis</i>	5%	0.0 ... 100%	
	Batch	Off		Batch (Page 79)
	• <i>Batch quantity</i>	0	Sensor size dependent	
	• <i>Batch compensation</i>	0	-100 ... +100 m <sup>3</sup>	
	• <i>Batch counter</i>	Down	Up, down	
	Frequency	Off	500 Hz, 1 kHz, 5 kHz, 10 kHz	Digital output - frequency (Page 78)
	• <i>Time constant</i>	5 s	0.1 ... 30 s	
	Pulse	On		Digital output - pulse (Page 78)
	• <i>Pulse polarity</i>	Positive	Positive, negative	
	• <i>Pulse width</i>	66 ms	64 μs, 130 μs, 260 μs, 510 μs, 1.0 ms, 2.0 ms, 4.1 ms, 8.2 ms, 16 ms, 33 ms, 66 ms, 130 ms, 260 ms, 520 ms, 1.0 s, 2.1 s, 4.2 s	
• <i>Volume/pulse</i>	Sensor size dependent	Dimension-dependent		
• <i>Time constant</i>	0.1 s	0.1 ... 30 s		
External input	External input	Off	Batch, reset totalizer, freeze output, forced output, off	External input (Page 80)
	• <i>Batch</i>	Start	Start, hold/continue, stop, Qmax 2	

Menu item	Parameter	Factory settings	Options	More info
Sensor characteristics	Correction factor	1	0.85 ... 2.00	Sensor characteristics (Page 81)
Language	Language	English	English, German, French, Danish, Swedish, Finnish, Spanish, Russian, Italian, Portuguese, Polish	Changing language (Page 46)
Operator menu	Primary field	Flow rate	Flow rate, Totalizer 1, Totalizer 2	Changing operator menu setup (Page 45)
	Title/subtitle lines	Flow rate	Flow rate, Flow velocity, Qmax, Totalizer 1, Totalizer 2, Totalizer 1 reset, Totalizer 2 reset, Batch start/paused/stop, Batch cycle counter, Batch cycle counter reset, Sensor size, Sensor type, Error pending, Status log, Tag No.	

## B.2 50 Hz Dimension dependent

50 Hz Dimension dependent factory settings MAG 1100, MAG1100F, MAG 3100, MAG 3100 P and MAG 5100W with M20 cable glands

DN	Q <sub>max</sub> *					unit
	Factory setting	MAG 5100 W (Order no. 7ME6520)		MAG 1100, MAG 1100 F, 5100 W (Order no. 7ME6580) MAG 3100, 3100 P		
mm (inch)		min.	max.	min.	max.	
2 (1/12)	30	-	-	3.903623	156.1448	l/h
3 (1/8)	70	-	-	6.361726	254.469	l/h
6 (1/4)	300	-	-	25.44691	1017.876	l/h
10 (3/8)	900	-	-	70.68584	2827.433	l/h
15 (1/2)	2000	-	-	159.0432	6361.725	l/h
25 (1)	5000	441.7865	17671.45	441.7865	17671.45	l/h
40 (1 1/2)	12	1.130974	45.23893	1.130974	45.23893	m <sup>3</sup> /h
50 (2)	20	1.574527	62.98107	1.767146	70.68583	m <sup>3</sup> /h
65 (2 1/2)	30	2.499681	99.98723	2.986477	119.459	m <sup>3</sup> /h
80 (3)	50	4.003646	160.1458	4.523894	180.9557	m <sup>3</sup> /h
100(4)	120	6.252163	250.0864	7.068584	282.7433	m <sup>3</sup> /h
125 (5)	180	10.00647	400.2585	11.04467	441.7864	m <sup>3</sup> /h
150 (6)	250	15.74527	629.8107	15.90432	636.1725	m <sup>3</sup> /h
200(8)	400	24.93797	997.5184	28.27434	1130.973	m <sup>3</sup> /h
250(10)	700	40.00377	1600.15	44.17865	1767.145	m <sup>3</sup> /h
300 (12)	1000	62.50395	2500.157	63.61726	254469	m <sup>3</sup> /h
350 (14)	1200	86.59015	3463.605	86.59015	3463.605	m <sup>3</sup> /h

Factory settings

B.3 60 Hz Dimension dependent

DN	Q <sub>max</sub> *					
	Factory setting	MAG 5100 W (Order no. 7ME6520)		MAG 1100, MAG 1100 F, 5100 W (Order no. 7ME6580) MAG 3100, 3100 P		unit
mm (inch)		min.	max.	min.	max.	
400 (16)	1800	113.0974	4523.893	113.0974	4523.893	m <sup>3</sup> /h
450 (18)	2000	143.1389	5725.552	143.1389	5725.552	m <sup>3</sup> /h
500 (20)	3000	176.7146	7068.583	176.7146	7068.583	m <sup>3</sup> /h
600 (24)	4000	254.4691	10178.76	254.4691	10178.76	m <sup>3</sup> /h
700 (28)	4500	346.3606	13854.42	346.3606	13854.42	m <sup>3</sup> /h
750 (30)	5000	397.6079	15904.31	397.6079	15904.31	m <sup>3</sup> /h
800 (32)	7000	452.3894	18095.57	452.3894	18095.57	m <sup>3</sup> /h
900 (36)	9000	572.5553	22902.21	572.5553	22902.21	m <sup>3</sup> /h
1000 (40)	12000	706.8584	28274.33	706.8584	28274.33	m <sup>3</sup> /h
1050 (42)	12000	706.8584	28274.33	706.8584	28274.33	m <sup>3</sup> /h
1100 (44)	14000	855.986	34211.94	855.2986	34211.94	m <sup>3</sup> /h
1200 (48)	15000	1017.877	40715.04	1017.877	40715.04	m <sup>3</sup> /h
1400 (54)	25000	-	-	1385.443	55417.69	m <sup>3</sup> /h
1500 (60)	30000	-	-	1590.432	63617.25	m <sup>3</sup> /h
1600 (66)	35000	-	-	1809.558	72382.29	m <sup>3</sup> /h
1800 (72)	40000	-	-	2290.222	91608.84	m <sup>3</sup> /h
2000 (78)	45000	-	-	2827.434	113097.3	m <sup>3</sup> /h
2200 (90)	50000	-	-	3421.195	136847.7	m <sup>3</sup> /h
2400 (96)	55000	-	-	4071.505	162860.1	m <sup>3</sup> /h
2600 (102)	60000	-	-	4778.363	191134.4	m <sup>3</sup> /h
280 (114)	65000	-	-	5541.77	221670.7	m <sup>3</sup> /h
3000 (120)	70000	-	-	6361.726	254469	m <sup>3</sup> /h

\* The min. and max. amount values show mathematical values and do not indicate measurement accuracy



## B.3 60 Hz Dimension dependent

60 Hz Dimension dependent factory settings MAG 1100, MAG1100F, MAG 3100, MAG 3100 P and MAG 5100W with 1/2" NPT cable glands

DN	Q <sub>max.</sub>					unit
	Factory setting*	MAG 5100 W (Order no. 7ME6520)		MAG 1100, MAG 1100 F, 5100 W (Order no. 7ME6580) MAG 3100, 3100 P		
mm (inch)		min.	max.	min.	max.	
2 (1/12)	0.14	-	-	0.01718714	0.6874852	US GPM
3 (1/8)	0.31	-	-	0.02800984	1.120393	US GPM
6 (1/4)	1.4	-	-	0.1120394	4.481573	US GPM
10 (3/8)	4	-	-	0.3112204	12.44881	US GPM
15 (1/2)	9	-	-	0.7002459	28.0	US GPM
25 (1)	23	1.945128	77.80509	1.945128	77.80509	US GPM
40 (1 1/2)	53	4.979526	199.181	4.979526	199.181	US GPM
50 (2)	89	6.932434	277.2973	7.78051	311.2203	US GPM
65 (2 1/2)	133	11.00577	440.2305	13.14907	525.9624	US GPM
80 (3)	221	17.62753	705.1008	19.91811	796.7241	US GPM
100(4)	529	27.52745	1101.097	31.12204	1244.881	US GPM
125 (5)	793	44.05714	1762.285	48.62819	1945.127	US GPM
150 (6)	1101	69.32434	2772.973	70.02459		
200 (8)	1762	109.7986	4391.941		4979.525	
250 (10)	3083	176.1313	7045.251	194.5128		
300 (12)	4403	275.1967	11007.86	280.0984	11203.93	US GPM
350 (14)	5284	381.245	15249.79	381.245	15249.79	US GPM
400 (16)	7926	497.9526	19918.1	497.9526	19918.1	US GPM
450 (18)	8806	630.2213	25208.84	630.2213	25208.84	US GPM
500 (20)	13209	778.051	31122.03	778.051	31122.03	US GPM
600 (24)	17612	1120.394	44815.73	1120.394	44815.73	US GPM
700 (28)	19813	1524.98	60999.19	1524.98	60999.19	US GPM
750 (30)	22015	1750.615	70024.58	1750.615	70024.58	US GPM
800 (32)	3082	1991.811	79672.4	1991.811	79672.41	US GPM
900 (36)	39626	2520.885	100835.3	2520.885	100835.3	US GPM
1000 (40)	52835	3112.204	124488.1	3112.204	124488.1	US GPM
1050 (42)	52835	3112.204	137248.1	3112.204	124488.1	US GPM
1100 (44)	61641	3765.767	150630.6	3765.767	150630.6	US GPM
1200 (48)	66044	4481.574	179262.9	4481.574	179262.9	US GPM
1400 (54)	110072	-	-	6099.92	243996.7	US GPM
1500 (60)	1320867	-	-	7002.459	280098.3	US GPM
1600 (66)	154101	-	-	7967.242	318689.6	US GPM

Factory settings

B.4 50 Hz Dimension dependent batch and pulse output settings

DN	Q <sub>max.</sub>					unit
	Factory setting*	MAG 5100 W (Order no. 7ME6520)		MAG 1100, MAG 1100 F, 5100 W (Order no. 7ME6580) MAG 3100, 3100 P		
mm (inch)		min.	max.	min.	max.	
1800 (72)	176115	-	-	10083.54	403341.5	US GPM
2000 (78)	198130	-	-	12448.82	497952.5	US GPM
2200 (90)	220144	-	-	15063.07	602522.6	
	242158	-		17926.3	717051.7	
2600 (102)	264173	-	-	21038.5	841539.8	
2800 (114)	286187	-	-	24399.68	975987	
3000 (120)	308201	-	-	28009.84	1120393	

\* Factory setting sets Q<sub>max</sub> to a metric unit (see previous table). The values here are converted to rounded off US GPM.

B.4 50 Hz Dimension dependent batch and pulse output settings

50 Hz Dimension dependent factory settings MAG 1100, MAG1100F, MAG 3100, MAG 3100 P and MAG 5100W with ½" NPT cable glands

6DN	Volume/pulse or batch quantity*				Factory setting		
	MAG 5100 W (Order no. 7ME6520)		MAG 1100, MAG 1100 F, 5100 W (Order no. 7ME6580) MAG 3100, 3100 P		Volume/pulse & batch amount	Pulse & batch unit	Totalize r unit
mm (inch)	min.	max.	min.	max.			
2 (1/12)	-	-	3.61466 µl	94.75103 l	0.1	ml	ml
3 (1/8)	-	-	5.890487 µl	154.4155 l	0.1	ml	ml
6 (1/4)	-	-	23.56195 µl	617.6622 l	1	l	l
10 (3/8)	-	-	65.44985 µl	1.715728 m <sup>3</sup>	1	l	l
15 (1/2)	-	-	147.2622 µl	3.860389 m <sup>3</sup>	1	l	l
25 (1)	409.0616 µl	10.7233 m <sup>3</sup>	409.0616 µl	10.7233 m <sup>3</sup>	10	l	l**
40 (1 1/2)	1.047198 ml	27.45165 m <sup>3</sup>	1.047198 ml	27.45165 m <sup>3</sup>	10	l	l**
50 (2)	1.457896 ml	38.21785 m <sup>3</sup>	1.636247 ml	42.89321 m <sup>3</sup>	10	l	l**
65 (2 1/2)	2.31452 ml	60.67373 m <sup>3</sup>	2.765257 ml	72.48952 m <sup>3</sup>	100	l	l**
80 (3)	3.70708 ml	97.17886 m <sup>3</sup>	4.188791 ml	109.8066 m <sup>3</sup>	100	l	l**
100(4)	5.789039 ml	151.7561 m <sup>3</sup>	6.544985 ml	171.5728 m <sup>3</sup>	100	l	l**
125 (5)	9.265244 ml	242.8828 m <sup>3</sup>	10.22654 ml	268.0825 m <sup>3</sup>	100	l	m <sup>3</sup>
150 (6)	14.57896 ml	382.1785 m <sup>3</sup>	14.72622 ml	386.0389 m <sup>3</sup>	100	l	m <sup>3</sup>
200 (8)	23.09071 ml	605.309 m <sup>3</sup>	26.17994 ml	686.2913 m <sup>3</sup>	1	m <sup>3</sup>	m <sup>3</sup>

## B.4 50 Hz Dimension dependent batch and pulse output settings

6DN	Volume/pulse or batch quantity*				Factory setting		
	MAG 5100 W (Order no. 7ME6520)		MAG 1100, MAG 1100 F, 5100 W (Order no. 7ME6580) MAG 3100, 3100 P		Volume/pulse & batch amount	Pulse & batch unit	Totalizer unit
mm (inch)	min.	max.	min.	max.			
250 (10)	37.04053 ml	970.995 m <sup>3</sup>	40.90616 ml	1072.33 m <sup>3</sup>	1	m <sup>3</sup>	m <sup>3</sup>
300 (12)	57.87403 ml	1517.132 m <sup>3</sup>	58.90487 ml	1544.155 m <sup>3</sup>	1	m <sup>3</sup>	m <sup>3</sup>
350 (14)	80.17607 ml	2101.767 m <sup>3</sup>	80.17607 ml	210.7671 m <sup>3</sup>	1	m <sup>3</sup>	m <sup>3</sup>
400 (16)	104.7198 ml	2745.165 m <sup>3</sup>	104.7198 ml	2745.165 m <sup>3</sup>	1	m <sup>3</sup>	m <sup>3</sup>
450 (18)	132.536 ml	3474.35 m <sup>3</sup>	132.536 ml	3474.35 m <sup>3</sup>	1	m <sup>3</sup>	m <sup>3</sup>
500 (20)	163.6247 ml	4289.321 m <sup>3</sup>	163.6247 ml	4289.321 m <sup>3</sup>	10	m <sup>3</sup>	m <sup>3</sup>
600 (24)	235.6195 ml	6176.622 m <sup>3</sup>	235.6195 ml	6176.622 m <sup>3</sup>	10	m <sup>3</sup>	m <sup>3</sup>
700 (28)	320.7043 ml	8407.069 m <sup>3</sup>	320.7143 ml	8407.069 m <sup>3</sup>	10	m <sup>3</sup>	m <sup>3</sup>
750 (30)	368.1554 ml	9650.972 m <sup>3</sup>	368.1554 ml	9650.972 m <sup>3</sup>	10	m <sup>3</sup>	m <sup>3</sup>
800 (32)	418.8791 ml	10980.66 m <sup>3</sup>	418.8791 ml	10980.66 m <sup>3</sup>	10	m <sup>3</sup>	m <sup>3</sup>
900 (36)	530.1438 ml	13897.4 m <sup>3</sup>	530.1438 ml	13897.4 m <sup>3</sup>	10	m <sup>3</sup>	m <sup>3</sup>
1000 (40)	654.4985 ml	17157.28 m <sup>3</sup>	654.4985 ml	17157.28 m <sup>3</sup>	10	m <sup>3</sup>	m <sup>3</sup>
1050 (42)	654.4985 ml	17157.28 m <sup>3</sup>	654.4985 ml	17157.28 m <sup>3</sup>	10	m <sup>3</sup>	m <sup>3</sup>
1100 (44)	79.94321 ml	20760.31 m <sup>3</sup>	79.94321 ml	20760.31 m <sup>3</sup>	10	m <sup>3</sup>	m <sup>3</sup>
1200 (48)	942.4778 ml	24706.48 m <sup>3</sup>	942.4778 ml	24706.48 m <sup>3</sup>	10	m <sup>3</sup>	m <sup>3</sup>
1400 (54)	-	-	1.282817 l	33628.27 m <sup>3</sup>	10	m <sup>3</sup>	m <sup>3</sup>
1500 (60)	-	-	1.472622 l	38603.89 m <sup>3</sup>	10	m <sup>3</sup>	m <sup>3</sup>
1600 (66)	-	-	1.675517 l	43922.64 m <sup>3</sup>	10	m <sup>3</sup>	m <sup>3</sup>
1800 (72)	-	-	2.120576 l	55589.6 m <sup>3</sup>	10	m <sup>3</sup>	m <sup>3</sup>
2000 (78)	-	-	2.617994 l	68629.13 m <sup>3</sup>	10	m <sup>3</sup>	m <sup>3</sup>
2200 (90)	-	-	3.167773 l	83041.25 m <sup>3</sup>	10	m <sup>3</sup>	m <sup>3</sup>
2400 (96)	-	-	3.769912 l	98825.9 m <sup>3</sup>	10	m <sup>3</sup>	m <sup>3</sup>
2600 (102)	-	-	4.4241 l	115983. m <sup>3</sup>	10	m <sup>3</sup>	m <sup>3</sup>
2800 (114)	-	-	5.131268 l	134513.1 m <sup>3</sup>	10	m <sup>3</sup>	m <sup>3</sup>
3000 (120)	-	-	5.890487 l	154415.5 m <sup>3</sup>	10	m <sup>3</sup>	m <sup>3</sup>

\* The min. and max. amount values show mathematical values and do not indicate measurement accuracy.

\*\* For CT devices the totalizer 1 unit is in m<sup>3</sup>

## B.5 60 Hz Dimension dependent batch and pulse output settings

60 Hz Dimension dependent factory settings MAG 1100, MAG1100F, MAG 3100, MAG 3100 P and MAG 5100W with 1/2" NPT cable glands

DN	Volume/pulse or batch quantity			
	MAG 5100 W (Order no. 7ME6520)		MAG 1100, MAG 1100 F, 5100 W (Order no. 7ME6580) MAG 3100, 3100 P	
mm (inch)	US G min.	US G max.	US G min.	US G max.
2 (1/12)	-	-	0.00000095484069	25.03057
3 (1/8)	-	-	0.000001556102	40.79227
6 (1/4)	-	-	0.000006224408	163.1691
10 (3/8)	-	-	0.00001729003	453.2475
15 (1/2)	-	-	0.00003890255	1019.806
25 (1)	0.0001080627	2832.796	0.0001080627	2832.796
40 (1 1/2)	0.0002766404	7251.96	0.0002766404	7251.96
50 (2)	0.0003851353	10096.08	0.0004322506	11331.18
65 (2 1/2)	0.0006114314	16028.3	0.0007305034	19149.7
80 (3)	0.0009793068	25671.93	0.001106562	29007.84
100(4)	0.001529303	40089.74	0.001729003	45324.75
125 (5)	0.002447619	64162.85	0.002701566	70819.92
150 (6)	0.003851353	100960.8	0.003890255	101980.6
200 (8)	0.00609992	159905.7	0.006916009	181299
250 (10)	0.009785071	256509.7	0.01080627	283279.6
300 (12)	0.01528871	400784.1	0.01556102	407922.7
350 (14)	0.02118028	555228.2	0.02118028	555228.2
400 (16)	0.02766404	725196	0.02766404	725196
450 (18)	0.0350123	917826.2	0.0350123	917826.2
500 (20)	0.04322506	1133118	0.04322506	1133118
600 (24)	0.06224408	1631691	0.06224408	1631691
700 (28)	0.0847211	2220912	0.0847211	2220912
750 (30)	0.09725637	2549517	0.09725637	2549517
800 (32)	0.1106562	2900784	0.1106562	2900784
900 (36)	0.1400492	3671304	0.1400492	3671304
1000 (40)	0.1729003	4532475	0.1729003	4532475
1050 (42)	0.1729003	4532475	0.1729003	4532475
1100 (44)	0.2092093	5484294	0.2092093	5484294
1200 (48)	0.2489763	6526764	0.2489763	6526764
1400 (54)	-	-	0.3388844	8883651
1500 (60)	-	-	0.3890255	10198060
1600 (66)	-	-	0.4426246	11603130
1800 (72)	-	-	0.5601967	14685210

B.5 60 Hz Dimension dependent batch and pulse output settings

DN	Volume/pulse or batch quantity			
	MAG 5100 W (Order no. 7ME6520)		MAG 1100, MAG 1100 F, 5100 W (Order no. 7ME6580) MAG 3100, 3100 P	
mm (inch)	US G min.	US G max.	US G min.	US G max.
2000 (78)	-	-	0.6916009	18129900
2200 (90)			0.836837	21937170
2400 (96)			0.995906	26107050
2600 (102)			1.168806	30639530
2800 (114)			1.355538	35534600
3000 (120)			1.556102	40792270





## Approvals/Certificates

All certificates are posted on the Internet. Additionally, the CE Declaration of Conformity as well as ATEX approvals are available on the SITRANS F literature CD-ROM.

Certificates (<http://support.automation.siemens.com/WW/view/en/10806951/134200>)





# Index

## A

Add-on module, 15  
Add-on modules  
    Electrical connection: Add-on modules, 38  
Alarm differentiation, 47  
Alarm level, 47

## C

Communication module, (See Add-on module)  
Compliance, 11  
Contact person, 9  
Customer Support Hotline, 58

## D

Decontamination, 59  
Device  
    Identification, 8  
    Inspection, 7  
Diagnostic functions, 53

## E

Electrical connection, 38  
Error handling, 53

## H

Hotline, 58

## I

Installation  
    Indoor/outdoor, 19  
Internet  
    Contact person, 9, 59  
    Flow documentation, 9  
    Support, 59  
Introduction, 7

## L

Laws and directives, 11

## M

Mains supply, 35  
Maintenance, 57

## P

Protective conductor terminal, 35  
Protective earth, 35

## R

Recalibration, 60  
Repair, 58  
Return procedures, 59

## S

Safety  
    Instrument safety standards, 11  
Safety notes, 11  
Service, 58, 59  
Support, 59  
System components, 15

## W

Wire insulation, 35

## For more information

[www.siemens.com/flow](http://www.siemens.com/flow)

Siemens A/S  
Flow Instruments  
Nordborgvej 81  
DK-6430 Nordborg

Subject to change without prior notice  
Order No.: A5E02338368  
Lit. No.: A5E02338368-002  
© Siemens AG 12.2013



A5E02338368

[www.siemens.com/processautomation](http://www.siemens.com/processautomation)