

# 32A

## SOCKET & PLUGS

Zone 1,2,21,22

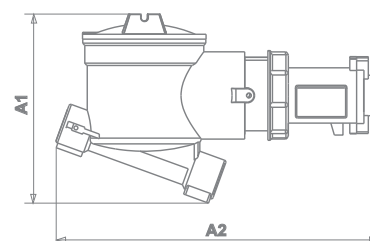
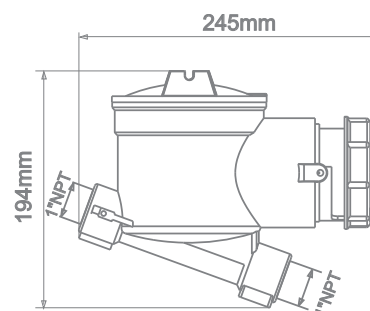
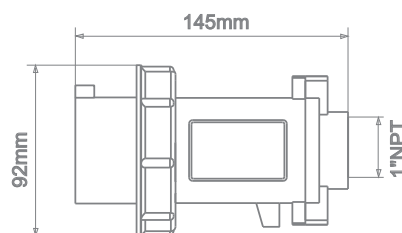

2014/34/EU  
IECEx System  
Management  
System  
Valid until:  
28.02.2021  
www.tuv.com  
ID: 910506338



### SPECIFICATION

**TYPE :** Ex plug and socket (32A)

**Material**

-Body & cover :

Aluminum alloy, copper free aluminum(as an option)

Polyamide cap with chain to prevent from losing

Brass pins Nickel plated

**Marking:** Ex II 2 G D

**Application:**

Ex d II C T6 Gb , Ex t III C T80°C Db

**Ambient Temperature :** -30°C to +55°C/-20°C to +40°C

**Rated Voltage:** Up to 690v (see the ordering table)

**Rated current :** Up to 32A

**Internal switch conductor size :** For 32A 2xM5(up to 8mm<sup>2</sup>)

**Frequency :** 50/60 Hz

**Rated Marking/Breaking capacity :** AC-3

**Ingress protection :**

IP 66 to IEC 60529 when plug inserted to socket

**Entries**

-Socket : 2x1 NPT,one plugged

(other thread forms available on request)

-Plugs : 1x1 NPT

EU type examination certificate:LOM 17ATEX1036X

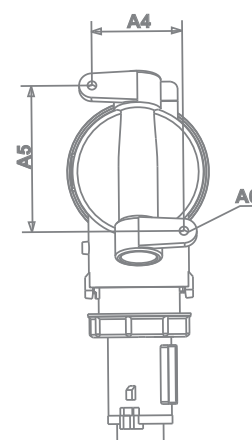
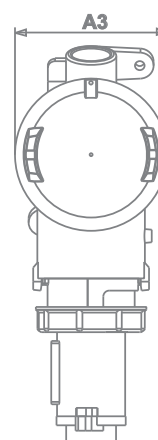

Size code	A1	A2	A3	A4	A5	A6
32A	194	340	127	81	139	Ø8

All information may be revised or changed by SHOMAL at anytime without prior notice or explanation.

32A

Ordering code system				
AA	Z	RE	C	XX
Body size	voltage( color)	RE: Socket PL:Plug	NO.OF PINS	Switching capacity
Socket Example			32 Y RE 4 32	
Plug Example		32 Y PL 4 32		









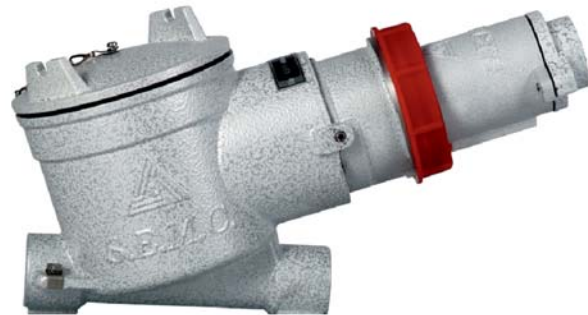

## SOCKET & PLUGS

Zone 1,2,21,22

Color code		
20 25 V	VIOLET	V
40 50 V	WHITE	W
(32A) 500V	BLACK	L
100 130 V	YELLOW	Y
200 250 V	BLUE	B
380 415 V	RED	R
(32A) 50V	GREEN	G
(63A): M.440V	SILVER	S

Body size
16
32
63



BODY SIZE	*ENTRY	SWITCHING CAPACITY	SOCKET(RE)	FREQUENCY(Hz)	NUMBER OF PINS	POLARITY	RATED VOLTAGE (V ca)	ARRANGEMENT	ORDERING CODE (AA Z RE/PL C XX)
32	NPT	32A			4	3P+E	20/25	 5h	32 V RE 432
							50	 2h	32 G RE 432
							100/130	 4h	32 Y RE 432
							200/250	 9h	32 B RE 432
							380/415	 6h	32 R RE 432
							440	 11h	32 R RE 432
							500	 7h	32 B RE 432

\*other pin arrangement available upon request