

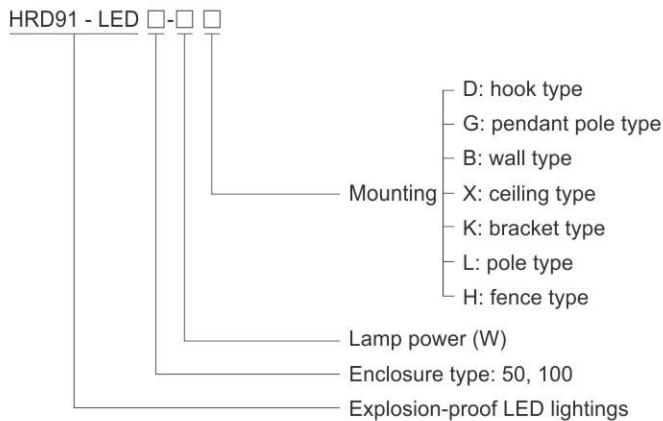

- ◆ Explosion protection to
 - CENELEC
 - IEC
 - NEC
- ◆ Can be used in
 - Zone 1 and Zone 2
 - Zone 21 and Zone 22
 - Class I, Zone 1 and Zone 2
 - Class I, Division 1, Groups A, B, C, D
- ◆ Two enclosure types:50, 100
- ◆ Applicable lamp and power (max.100W)
 - LED : 30W, 50W, 70W, 100W
- ◆ Isolated LED lamp compartment, CC-CV (constant current - constant voltage) power controller compartment and terminal compartment; Wind-convection heat dissipation structure
- ◆ Low-maintenance due to long service life is up to 100,000 operating hours.

■ Catalogue number logic



■ Selection table

Type / Ordering code	Lamp power(W)
HRD91-LED50-□ □	30, 50
HRD91-LED100-□ □	70, 100

Note: 1. Products above include all the mounting accessories listed in Mounting Accessories & Spare Parts Table (see P2/53).
2. The product is supplied according to "Type/Ordering code" in the table with mounting accessories.

Zones 1&2; 21&22

LED Light Fittings

HRD91-LED Series Explosion-proof LED Lightings

Technical data

Explosion-proof LED lightings HRD91-LED□-□□

Explosion protection

Global (IECEX)

Gas and dust

IECEX NEP 18.0022X

Ex db IIC T6 or T5 Gb

Ex tb IIIC T80°C or T95°C Db

Europe (ATEX)

TÜV CY 19 ATEX 0206175X

Gas and dust

⊕ II 2 G Ex db op is IIC T6...T5 Gb

⊕ II 2 G Ex db eb op is IIC T6...T5 Gb

⊕ II 2 D Ex tb op is IIIC T80°C...T95°C Db IP66

Certificates

IECEX; ATEX; CU-TR

Conformity to standards

EN 60079-0, EN 60079-1, EN60079-7, EN 60079-28, EN 60079-31

IEC 60079-0, IEC 60079-1, IEC60079-7, IEC 60079-28, IEC 60079-31

Material

Enclosure

Copper-free aluminium alloy, powder coated surface, yellow (RAL1021)

Transparent cover

Toughened glass, stands 4J impact

Exposed fastener

Stainless steel

LED driver

Wide voltage input, CC-CV (constant current - constant voltage) output, power factor ≥ 0.95 , with function of distributed current, constant current, surge-proof and anti-electromagnetic interference, and protection against overcurrent, open circuit, and short circuit

Lamp

Lamp specification

LED

Lamp power (W)

30W, 50W, 70W, 100W

Colour rendering index (Ra)

≥ 80

Colour temperature (CCT)

5700K

Note: cool white is available in general. Warm white or nature white is optional, please specify when ordering.

Rated voltage

220~240V AC 50/60Hz

100~277V AC 50/60Hz

Earthing protection

M5 (internal & external earth bolts)

Degree of protection

IP66

Ambient temperature

T6/T80°C for Tamb: -20°C~+43°C

T5/T95°C for Tamb: -20°C~+58°C

Terminal

3 x 1.5~4mm² (L+N+PE)

Mounting

Ceiling type, pole type, pendant pole type, wall type, bracket type, hook type, fence type

Cable entries

M25 x 1.5

Cable gland

See Mounting Accessories & Spare Parts Table

Available cable outer diameter

Φ 10~Φ 14(mm)



Dimension drawings (all dimensions in mm) - subject to alteration

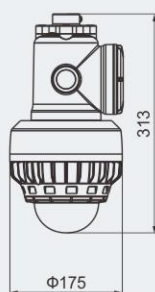

HRD91-LED50

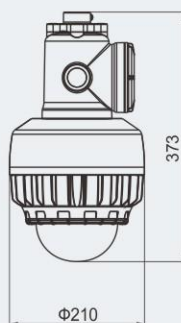

HRD91-LED100

Photometric data Note: LED luminous flux is from the standard product of which colour temperature is 5700K



HRD91-LED50-30-□

Lamp power (W)	Luminous flux	Wattage
30	3600lm	30W

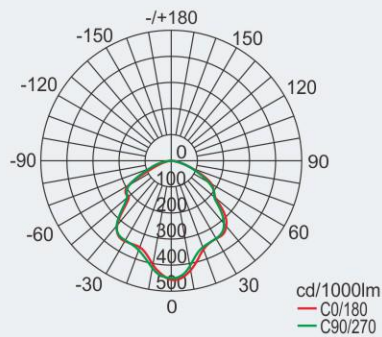

HRD91-LED100-70-□

Lamp power (W)	Luminous flux	Wattage
70	8400lm	70W

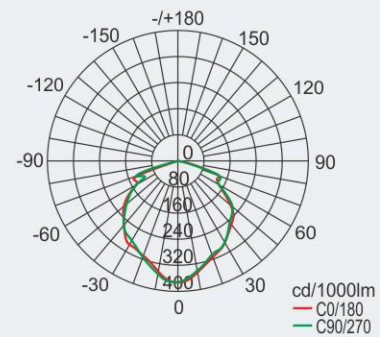

HRD91-LED50-50-□

Lamp power (W)	Luminous flux	Wattage
50	6100lm	50W

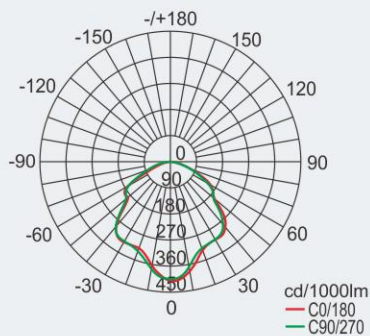

HRD91-LED100-100-□

Lamp power (W)	Luminous flux	Wattage
100	11200lm	100W

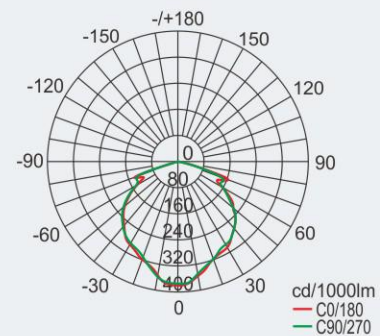

We can provide lighting design and data by professional lighting software DIALUX based upon simulated site situation on request.

LED Light Fittings

HRD91-LED Series Explosion-proof LED Lightings

Mounting type (all dimensions in mm) - subject to alteration

G: pendant pole type

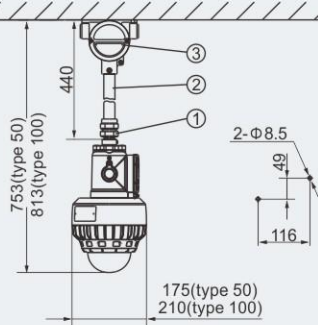

Weight: 3.75kg (type 50)
5.80kg (type 100)

Accessories supplied with the light fittings:

- ①. BGJ-III Explosion-proof connector G3/4"(M)/M25x1.5(F), Stainless steel.
- ②. Straight pipe (M25 x 1.5), length: 300mm.
- ③. BHD51-F (Ex d IIC, copper-free aluminium alloy), see P3/4.

D: hook type

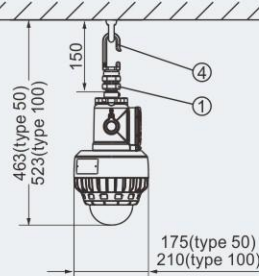

Weight: 2.75kg (type 50)
4.80kg (type 100)

Accessories supplied with the light fittings:

- ①. BGJ-III explosion-proof connector G3/4"(M)/M25 x 1.5(F), Stainless steel.
- ④. Hook (Stainless steel).

X: ceiling type

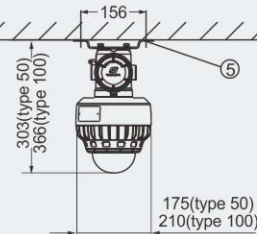

Weight: 3.30kg (type 50)
5.40kg (type 100)

Accessories supplied with the light fittings:

- ⑤. Mounting feet

B: wall type

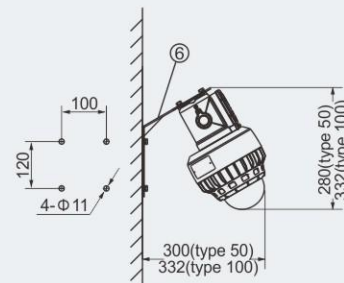

Weight: 3.30kg (type 50)
5.40kg (type 100)

Accessories supplied with the light fittings:

- ⑥. Wall bracket

K: bracket type

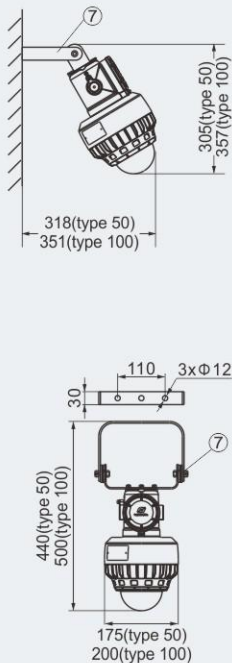

Weight: 4.00kg (type 50)
6.20kg (type 100)

Accessories supplied with the light fittings:

- ⑦. Mounting bracket, sheet steel, powder coated.

L: pole type

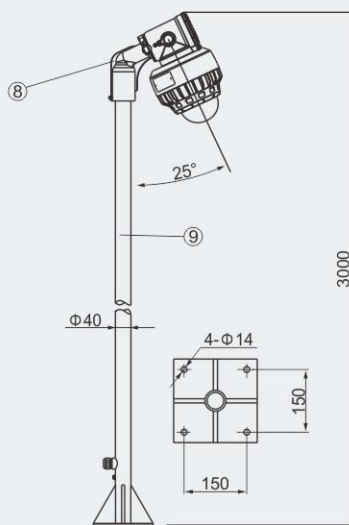

Weight: 2.75kg (type 50)
4.80kg (type 100)

Accessories supplied with the light fittings:

- ⑧. Pole type connector
- ⑨. Pole (shall be provided by user)

H: fence type

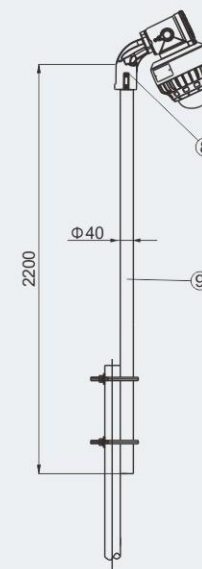

Weight: 2.75kg (type 50)
4.80kg (type 100)

Accessories supplied with the light fittings:

- ⑧. Pole type connector
- ⑨. Pole (shall be provided by user)